

# WWorkSpaces

*Ethics, aesthetics & ideas.*



---

# index

.2

*intro*

.4

## **pigreco**

private office 6

bench 10

meeting 26

.34

## **yard**

private office 36

bench 46

meeting 56

.72

## **vertebra spine**

.94

## **pod***partition*

.110

## **common***spaces*

.122

**imagine** *your space*

---



*L'ufficio è quel luogo in cui idee, creatività, innovazione e successo prendono forma. Da qui siamo partiti a concepire **workspaces**, sistemi che rispondono in maniera integrata ed innovativa alle esigenze di benessere ed efficienza dei moderni spazi di lavoro.*

*Le bureau est le lieu où les idées, la créativité, l'innovation et le succès deviennent réels. À partir d'ici nous avons commencé à concevoir "**workspaces**", des systèmes intégrés qui répondent aux besoins de bien-être et d'efficacité des espaces de travail modernes.*

---

Office is the place where ideas, creativity, innovation and success become real. From here we started to concept **workspaces**, integrated systems that meet the needs of wellness and efficiency of modern working spaces.

---

---

# THE HEART OF **pigreco**

---

**Pigreco** è un sistema ufficio altamente innovativo che rompe con gli schemi convenzionali, progettato per interpretare e vivere al meglio i luoghi di lavoro direzionali, operativi e meeting. L'elemento principale del sistema **Pigreco** è una struttura facile e veloce da montare, composta dalla identificativa gamba a cavalletto - disponibile in 2 finiture base: bianco o titanio, e in 6 colori laccati - e da una trave centrale attrezzabile per l'elettrificazione. La struttura di **Pigreco** è montabile a secco e per questo upgradabile e facilmente riconfigurabile.

**Pigreco** est un système de bureau très innovant qui rompt avec les systèmes conventionnels, conçu pour interpréter et vivre au mieux les lieux de travail directionnels, opératifs et de réunions. L'élément principal du système **Pigreco** est sa structure rapide et facile à assembler, composé par la base "à tréteau" - disponible en deux finitions: blanc ou titanio et en 6 couleurs laqués - et une poutre centrale qui peut être équipé pour l'électrification. L'assemblage de la structure de **Pigreco** est à sec et donc extensible et peut être facilement reconfiguré.

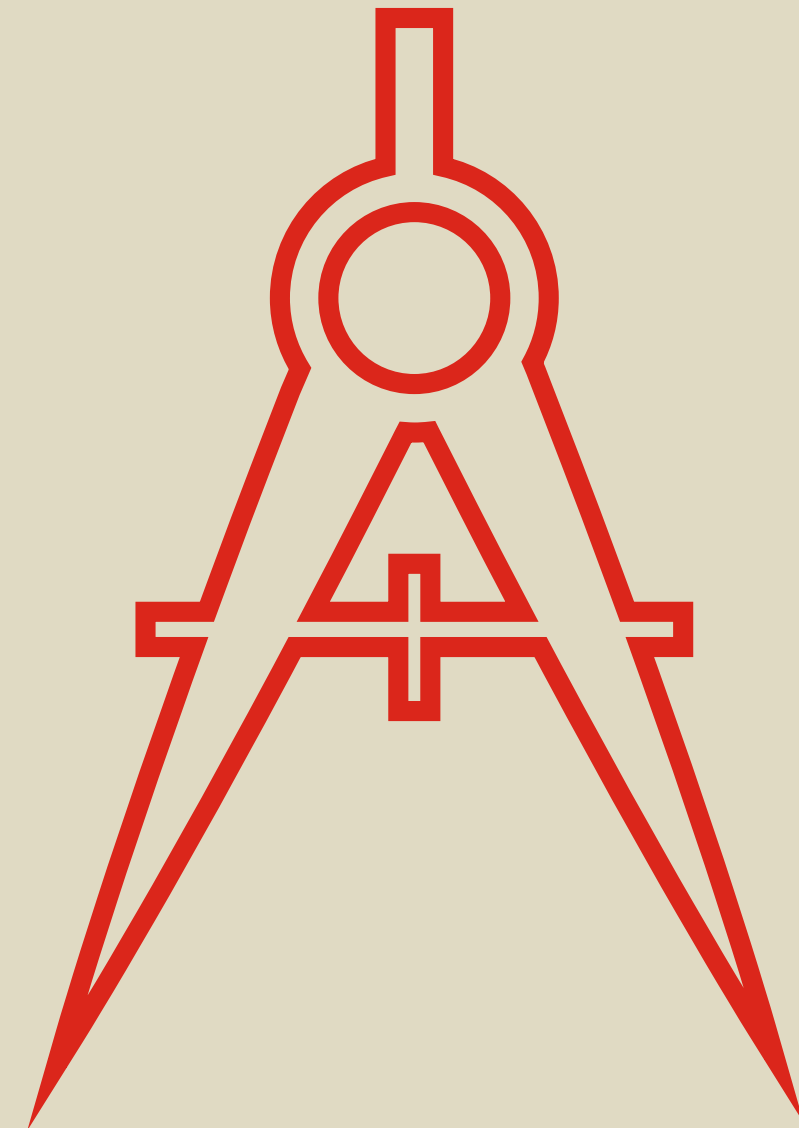

**Pigreco** is a highly innovative system that breaks the conventional schemes, designed to interpret and live the workplace in a best possible way being that executive, operational or meeting. The pricipal element of **Pigreco** system is the frame that has been designed so to be simple and easy to install. It is composed by its distinguished compass shape leg - available in 2 standard colours: white and titanio and in 6 optional lacquered colours - and by a central beam equippable for electrification. The **Pigreco** frame can be installed easily and for this reason it is upgradable and easy to reconfigure.



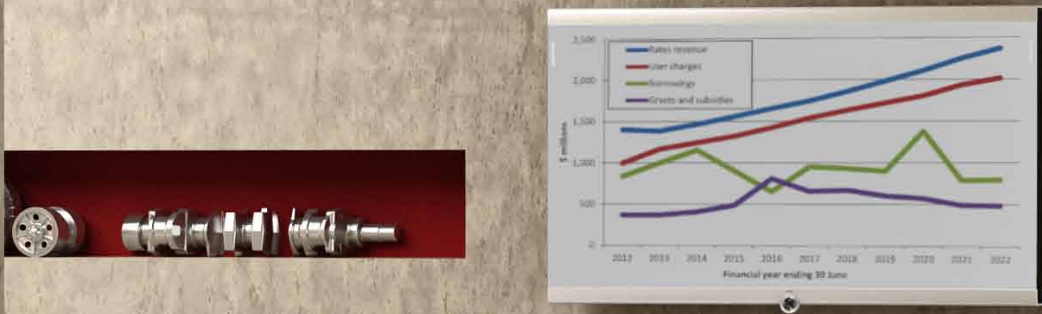





onespace

*Pigreco desk W. 2000 D. 1000 mm nocino desk top,  
titanio legs with structural modular cabinet W. 400 D.  
1600 mm (open unit, 3 drawers pedestal and hinged  
door cabinet) crema matt lacquered.*

*Scrivania Pigreco L. 2000 P. 1000 mm piano nocino e  
gambe titanio con mobile strutturale componibile L. 400  
P. 1600 mm (vano a giorno, contenitore a 3 cassetti e  
contenitore con anta) tutto laccato crema.*

*Bureau Pigreco L. 2000 P. 1000 mm, plateau en nocino  
et pieds titanio avec meuble structurel modulaire L. 400  
P. 1600 mm (mueble ouvert, meuble 3 tiroirs et meuble  
avec porte) laqué crema.*





---

# THE INNOVATION OF **pigrecobench**

*Innovative metal structure composed by a single central beam that allows a total span of 3600 mm without any central supporting element though guaranteeing proper strength and support. The structure allows wire management and cable riser through side legs with compass design. The base of the central beam provides support of the wire basket and frontal screens leaving the composition clean and essential. Desktops of 30 mm thickness complete the structural elements.*

🔗 *Span max 3600 mm*



*Struttura innovativa composta da un'unica trave metallica centrale che permette campate fino a 3600 mm senza ausilio di supporto centrale, garantendo stabilità e possibilità di gestire il cablaggio attraverso le gambe laterali a compasso. La base della trave centrale costituisce l'elemento di supporto per vaschette porta cavi e screen frontali, lasciando la composizione pulita ed essenziale. Piani scrivania da 30 mm completano gli elementi strutturali.*

🔗 *Campata massima 3600 mm*

*Structure composée par une poutre métallique centrale unique qui permet une portée totale de 3600 mm sans aucune élément de support central, garantissant stabilité et gestion du câblage à travers les pieds latéraux «à compas». La base de la poutre centrale fournit un support pour les bacs passe-câbles et les cloisonettes frontaux, laissant la composition sobre et essentielle. Plateaux bureau de 30 mm complètent les éléments structurels.*

🔗 *Portée maximale de 3600 mm*

---

# *Pigreco* details



*White cable port and screen in Cat. F  
100% pure new wool azzurro polvere.*



*Passacavo bianco e screen Cat. F in  
100% pura lana azzurro polvere.*



*Passe câble blanc et cloisonette Cat.  
F in 100% pure laine vierge azzurro  
polvere.*





*Pigreco bench W. 3600 D. 1600 mm  
white melamine desk top, olmo edge  
and white structure, azzurro polvere  
lacquered screen, marron glacé  
flipper.*

*Bench Pigreco L. 3600 P. 1600 mm  
piani melaminico bianco con bordo  
olmo e struttura bianca, screen  
laccato azzurro polvere, flipper  
laccato marron glacé.*

*Bench Pigreco L. 3600 P. 1600 mm  
plateaux melamine blanc avec bord  
orme et structure blanc, cloisonette  
laqué azzurro polvere, flipper laqué  
marron glacé.*



# smart & invisible WIRING

The Design Concept of **pigreco** worked on aesthetics but also on easy assembling and quick installation process that result particularly easy and intuitive.

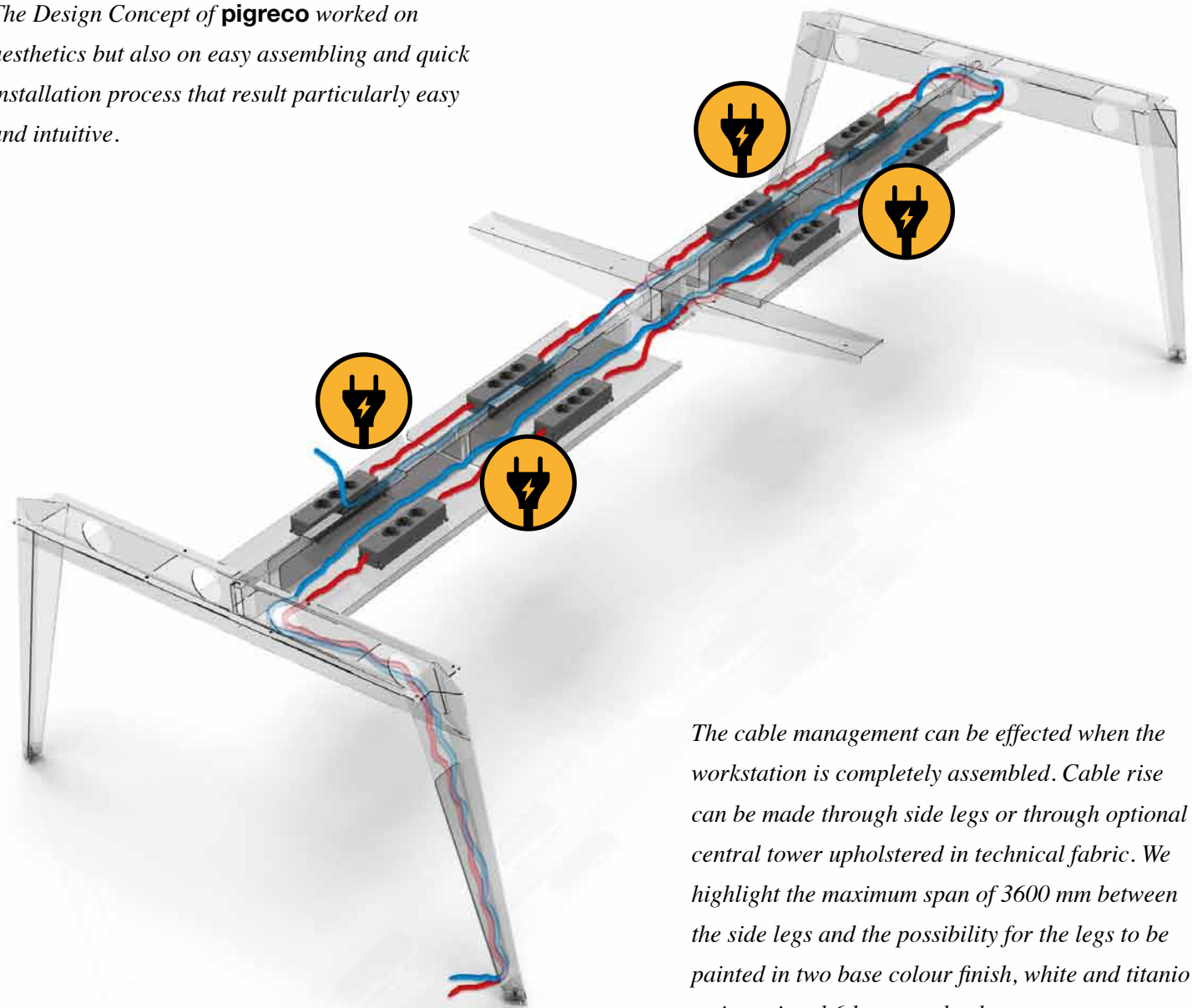

The cable management can be effected when the workstation is completely assembled. Cable rise can be made through side legs or through optional central tower upholstered in technical fabric. We highlight the maximum span of 3600 mm between the side legs and the possibility for the legs to be painted in two base colour finish, white and titanio or in optional 6 lacquered colours.

4 x

6 x

8 x

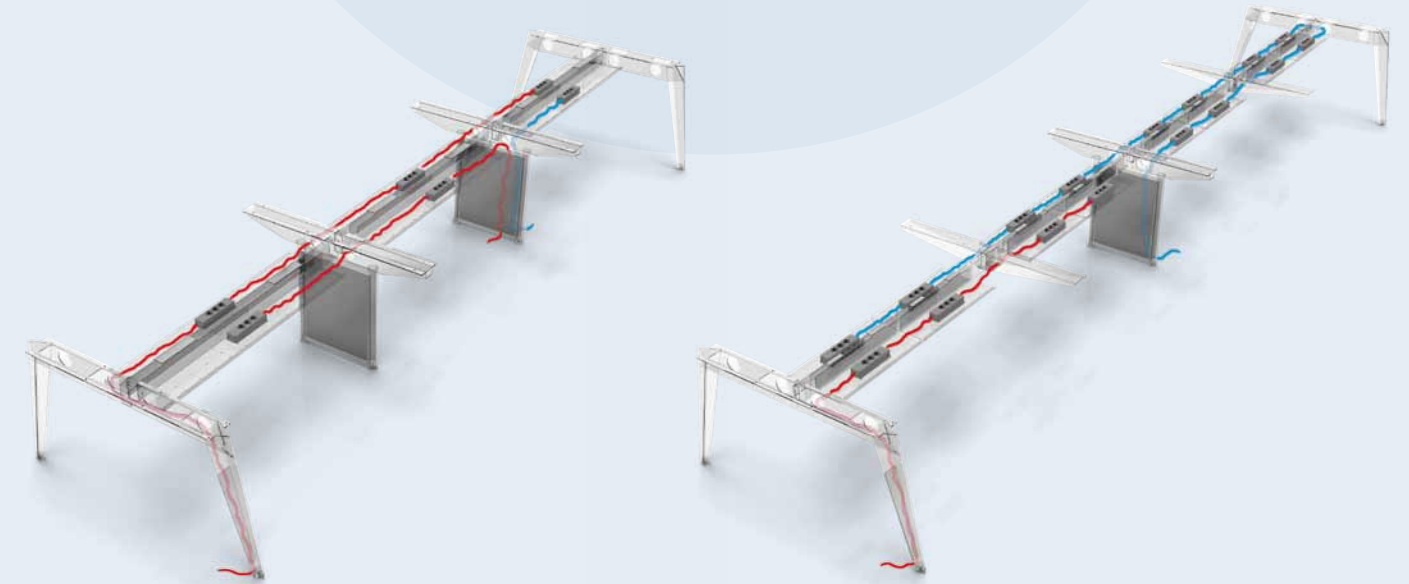

Il Concept Design di **pigreco** ha lavorato sull'estetica, ma anche sulla facilità di montaggio ed assemblaggio che risultano particolarmente semplici ed intuitivi. Il posizionamento dei cavi, che di solito viene eseguito a strutture semiallestate, interrompendo così il lavoro di assemblaggio, può essere effettuato, invece, a bench completamente montati. La salita cavi può avvenire lungo la gamba a compasso oppure tramite la gamba elettrificabile centrale rivestita in tessuto. Si evidenziano la luce massima tra le due gambe fino a 3600 mm e la disponibilità, per le gambe, di due finiture base bianco e titanio e in opzione di 6 colori laccati.

Le Concept Design de **pigreco** a travaillé sur l'esthétique, mais aussi sur la facilité d'installation et de montage qui sont particulièrement simples et intuitives. Le positionnement des câbles, qui a habituellement lieu à des structures partiellement montées en bloquant le travail de montage, peut être effectué une fois le bench est complètement monté. La remontée des câbles peut passer par le pied «à compas» ou à travers le pied central électrisable recouvert de tissu. En évidence le maximum de décalage entre les deux pieds aux extrémités allant jusqu'à 3600 mm et la disponibilité, pour les pieds de deux finitions de base bianco e titanio et en option de 6 couleurs de laques.









*Pigreco bench W. 4800 D. 1600 mm with olmo melamine desk tops, titanio legs and two structural electrificable legs. Screen Cat. C Nativa, grigio scuro.*

*Bench Pigreco L. 4800 P. 1600 mm piani melaminico olmo, gambe titanio e due gambe strutturali elettrificabili. Screen in tessuto Cat. C Nativa grigio scuro.*

*Bench Pigreco L. 4800 P. 1600 mm, plateaux mélamine olmo, pieds titanio et deux pieds électrifiables structurels. Cloisonette en tissu Cat. C Nativa grigio scuro.*





# cable management



*For the stand-alone desks there are different electrification solutions available: **1.** Cable rise through side leg with metal cover or through cable vertebra. **2.** Cable management through wire basket located under the table top. **3.** Ergonomic cable outlets that can be located on left, right or central position in the desktop.*

*Nelle scrivanie singole sono possibili diverse soluzioni di elettrificazione: **1.** Salita cavi su gamba con carter o tramite vertebra. **2.** Alloggiamento dei cavi sotto piano tramite vaschetta. **3.** Uscita cavi sul piano tramite ergonomici sportelli, posizionabili a dx, sx o al centro del piano.*

*Dans les bureaux individuels il y a plusieurs solutions d'électrification: **1.** Remontée câbles dans le pied avec cache ou par vertèbre. **2.** Logement des câbles sous plateau par goulotte. **3.** Sorties câbles sur le plan par trappes positionnés à droite, gauche ou au centre du plateau.*

**1.** Cable raise through leg and leg cover. **2.** Central cable raiser (not structural) for composition of 4/8 pax for central floor box wire access. **3.** Central structural cable tower upholstered in technical fabric for compositions of 6/8 pax. **4.** On desk grommet white painted or lacquered. **5.** On desk flipper cable port.



**1.** Copertura per salita cavi su gamba. **2.** Carter centrale in metallo (non strutturale) per composizioni da 4/8 posti con accesso cavi dal pavimento. **3.** Gamba strutturale centrale elettrificabile rivestita in tessuto tecnico per composizioni da 6/8 posti. **4.** Passacavo bianco o laccato opaco. **5.** Flipper per uscita cavi sulla scrivania.

**1.** Cache câbles pour remontée dans le pied. **2.** Carter en métal (non structurel) pour les compositions par 4/8 postes avec accès câble du sol. **3.** Pied central structurel électrisable revêtu en tissu technique pour les compositions par 6/8 postes. **4.** Trappe blanc ou laqué mat. **5.** Flipper sortie de câble sur le plateau du bureau.

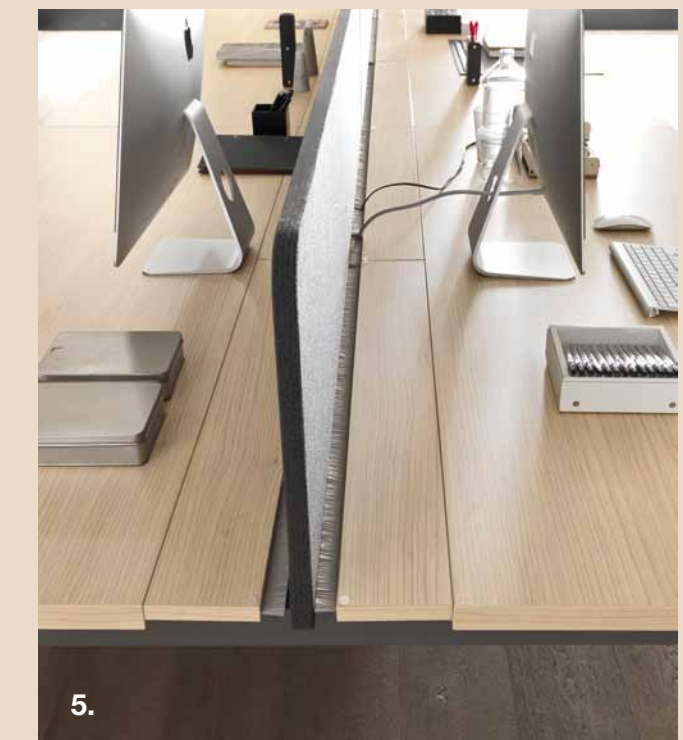







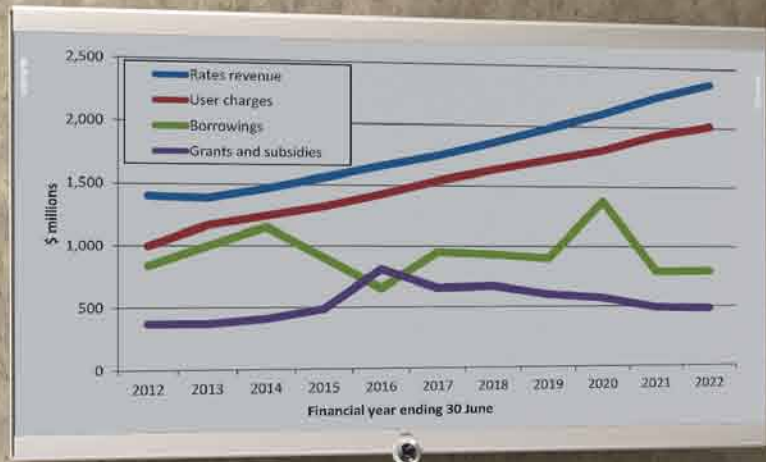



---

*imagine*  
**your space**



4 × 

Meeting table  
Ø 1200 mm

Tavolo meeting  
Ø 1200 mm

Table réunion  
Ø 1200 mm

---

**pigreco**meeting

6 × 



  
**sharingspace**

Meeting table  
W. 2400 D. 1200 mm

Tavolo meeting  
L. 2400 P. 1200 mm

Table réunion  
L. 2400 P. 1200 mm

---

*imagine your space*

---

# *cable* management

---

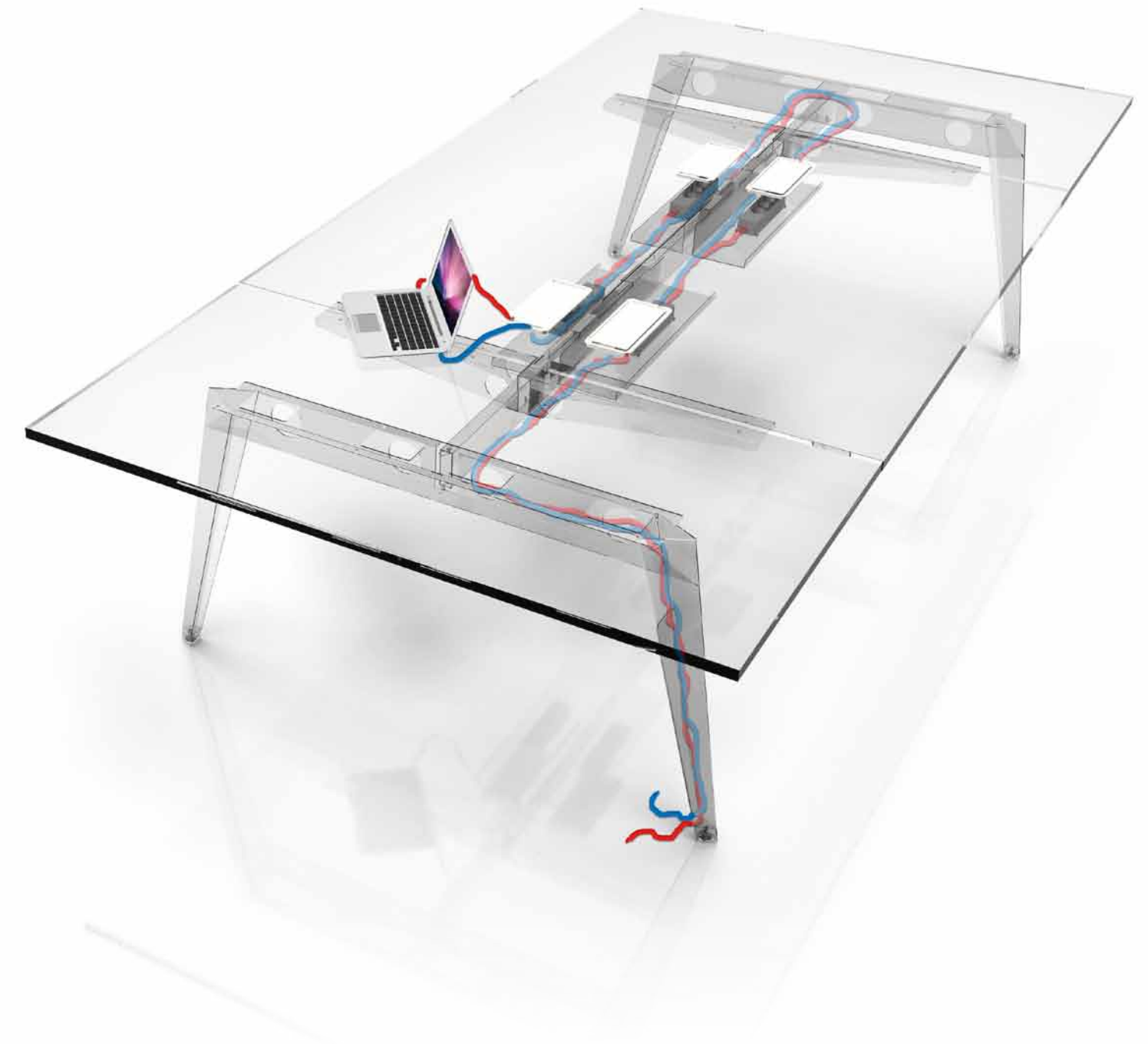

- 1.** Cable management through side legs and metal cover.
  - 2.** Cable trays connected to the metal beam under the desktop.
  - 3.** Cable access through flip top or flipper.
- 1.** Salita cavi con carter su gamba.
  - 2.** Vaschette sottopiano agganciate alla trave.
  - 3.** Uscita cavi con sportello o flipper.
- 1.** Montée des câbles avec carter pour pied.
  - 2.** Bacs porte câbles sous plateau fixés aux poutres.
  - 3.** Sortie des câbles par porte ou flipper.



---

# THE SIGN OF **yard**

---

*Yard recupera, nelle forme della struttura, la magica semplicità dei tre elementi che la contraddistinguono. I due montanti verticali sono collegati dalla traversa superiore a formare un portale che comunica forza e semplicità.*

*Yard trouve dans les formes de sa structure, la simplicité magique des trois éléments qui la différencient. Les deux poutres verticales sont connectés par la poutre supérieure, pour former un portique qui communique force et simplicité.*

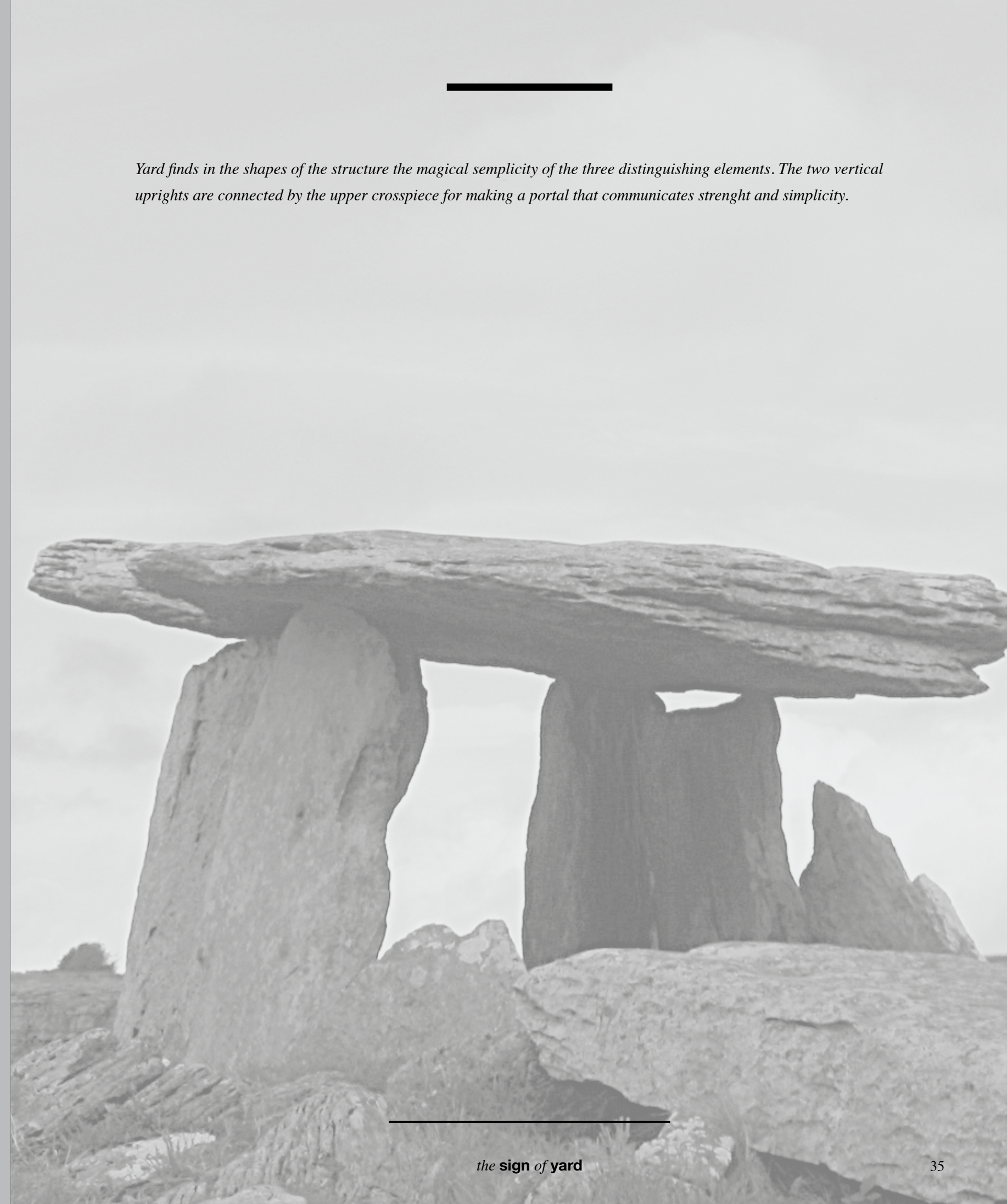

*Yard finds in the shapes of the structure the magical simplicity of the three distinguishing elements. The two vertical uprights are connected by the upper crosspiece for making a portal that communicates strength and simplicity.*



**onespace**

*On the right: Yard desk W. 1600 D. 1600 mm fondente lacquered desk top, white legs. Galaxy storage, Linear door, W. 3630 H. 806 mm.*

*\* See catalogue and pricelist Galaxy Storages.*

*Below: same desk with grigio chiaro legs version.*

*A destra: scrivania Yard L. 1600 P. 1600 mm piano laccato fondente gambe bianche. Contenitore Galaxy, anta Linear, L. 3630 H. 806 mm.*

*\* Vedi listino e catalogo Galaxy Storages.*

*Sotto: stessa scrivania con la variante gambe laccate grigio chiaro.*

*Droit: bureau Yard L. 1600 P. 1600 mm, plateau en fondente et pieds blanc. Meuble Galaxy, portes Linear, L. 3630 H. 806 mm.*

*\* Voir le catalogue et tarif Galaxy Storages.*

*Ci-dessous: même bureau dans la version avec pieds laqués grigio chiaro.*





---

# *single desk*



*Above: desk W. 2000 D. 1000 mm  
with white lacquered glass top.*

*On the left: desk with return  
W. 1800 D. 1600 mm top and legs  
amarena lacquered.*

*In alto: scrivania L. 2000 P. 1000 mm  
con piano vetro laccato bianco.*

*A sinistra: scrivania con dattilo  
L. 1800 P. 1600 mm piano e gambe  
laccate amarena.*

*En haut: bureau L. 2000 P. 1000 mm  
avec plateau en verre laqué blanc.*

*Gauche: bureau avec retour L. 1800  
P. 1600 mm plateau et pieds en laqué  
amarena.*



onespace

*Yard desk W. 1800 D. 800 mm with desktop in nocino and frame in white metal. On the side, height adjustable desk "Sit to Stand". On the back, Galaxy sliding doors cabinet W. 3600 H. 855 mm lacquered in crema colour.*

*Scrivania Yard L. 1800 P. 800 mm con piano finitura nocino e struttura bianca; a lato scrivania "Sit to Stand" regolabile in altezza. Contenitore anta scorrevole Galaxy L. 3600 H. 855 mm laccato crema.*

*Bureau Yard L. 1800 P. 800 mm avec plateau en nocino et structure métal blanc; à côté bureau réglable en hauteur "Sit to Stand". Meuble porte coulissante Galaxy L. 3600 H. 855 mm laqué crema.*





# adjustable desk

The correct height for the best ergonomy

**On request** *Yard adjustable leg*  
from **650 to 850 mm**



**Sit to Stand** *Adjustable height*  
from **730 to 1200 mm**

The height adjustable desks are always more important in the design of the new office because they offer flexibility and ergonomics, creating psycho-physical wellness.

Le scrivanie regolabili in altezza sono sempre più importanti nella progettazione dei nuovi uffici perchè, offrono flessibilità ed ergonomia, creando benessere psico-fisico.

Les bureaux réglables en hauteur sont de plus en plus importants dans la conception des nouveaux bureaux parce qu'ils offrent flexibilité et ergonomie, créant bien-être psychophysique.



Electrical height regulation "Sit-to-Stand". Available for single desk with metal structure or panel leg bench.

"Sit-to-Stand" con sistema elettrico. Disponibile nella versione scrivania singola con struttura in metallo o nella versione bench pannellato.

"Sit-to-Stand" avec système électrique. Disponible en version bureau simple avec structure en métal ou en version bench avec panneaux.



---

**yard**  
*bench &*  
*meeting*

---

---

**versatile**, *strong*,  
*functional*







---

# yard

## ELEMENTS

---

*On the left: th. 18 mm white screen, with olmo edge; the screen is also available all white, olmo, nocino and silicio melamine, lacquered or fabric. Above: pedestal on castors lacquered in blu marine color. Full extractable filing drawer.*

*A sinistra: screen sp. 18 mm bianco con bordo olmo; lo screen è anche disponibile tutto melaminico bianco, olmo, nocino e silicio, laccato o tessuto.*

*Sopra: cassettiere su ruote laccate blu marine. Classificatore ad estrazione totale.*

*À gauche: cloisonette ép. 18 mm blanc avec bord olmo; cloisonette est aussi disponible en mélamine blanc, olmo, nocino et silicio, laqué ou en tissu.*

*Ci-dessus: caissons sur roulettes en laqué blu marine. Tiroir DS à extraction totale.*

---

**multi** *purpose*  
*workstation*





*Mobile desk and storage give the possibility of space re-configuration with different solutions based on communication needs.*

*Scrivania e contenitori mobili danno la possibilità di ri-configurare lo spazio con diverse soluzioni in funzione alle esigenze di comunicazione.*

*Bureau et meubles permettent dereconfigurer l'espace avec différentes solutions, en fonction des exigences de communication.*





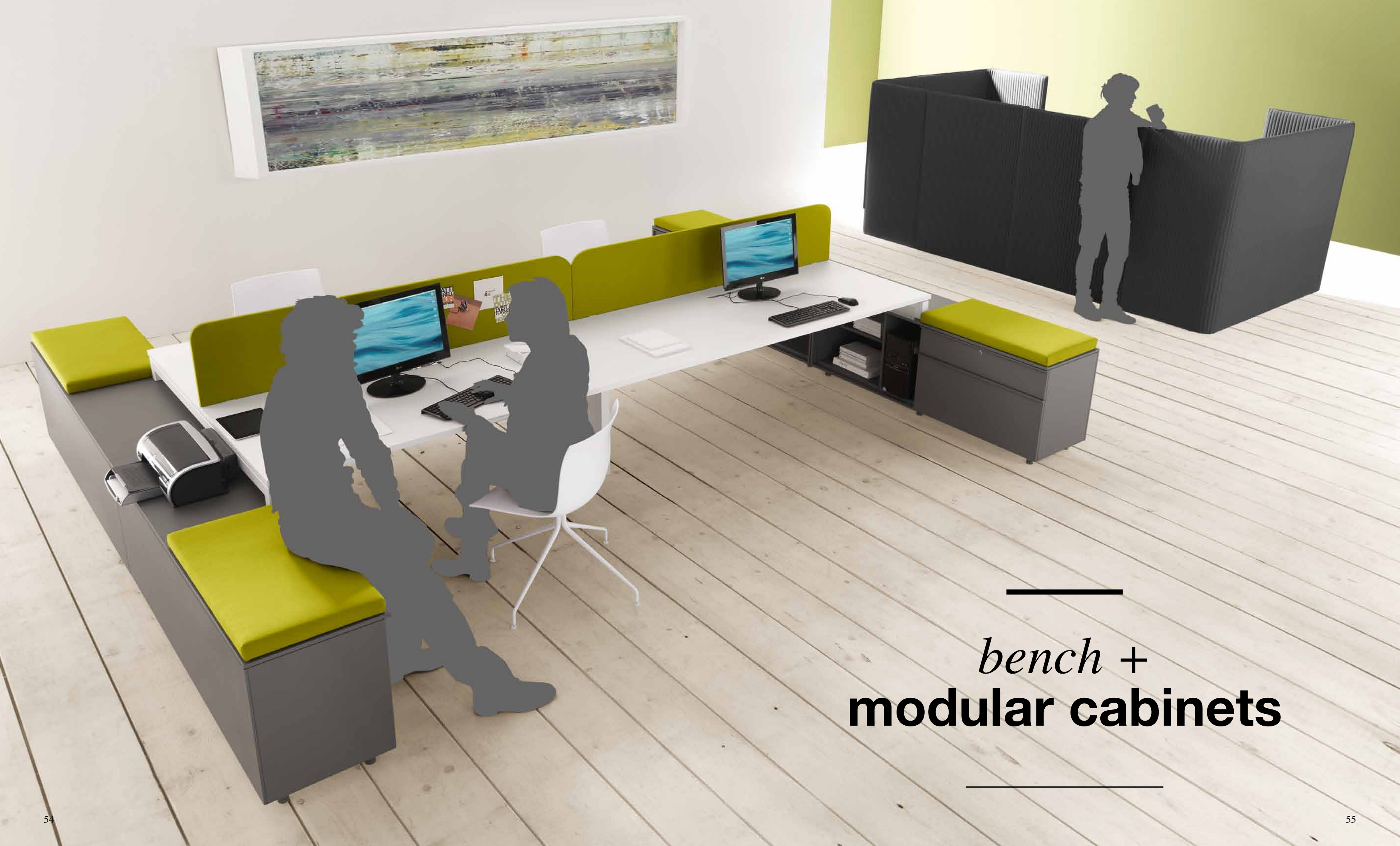

---

*bench +*  
**modular cabinets**

---



8 x 

  
sharingspace



---

**team**  
*working*

---







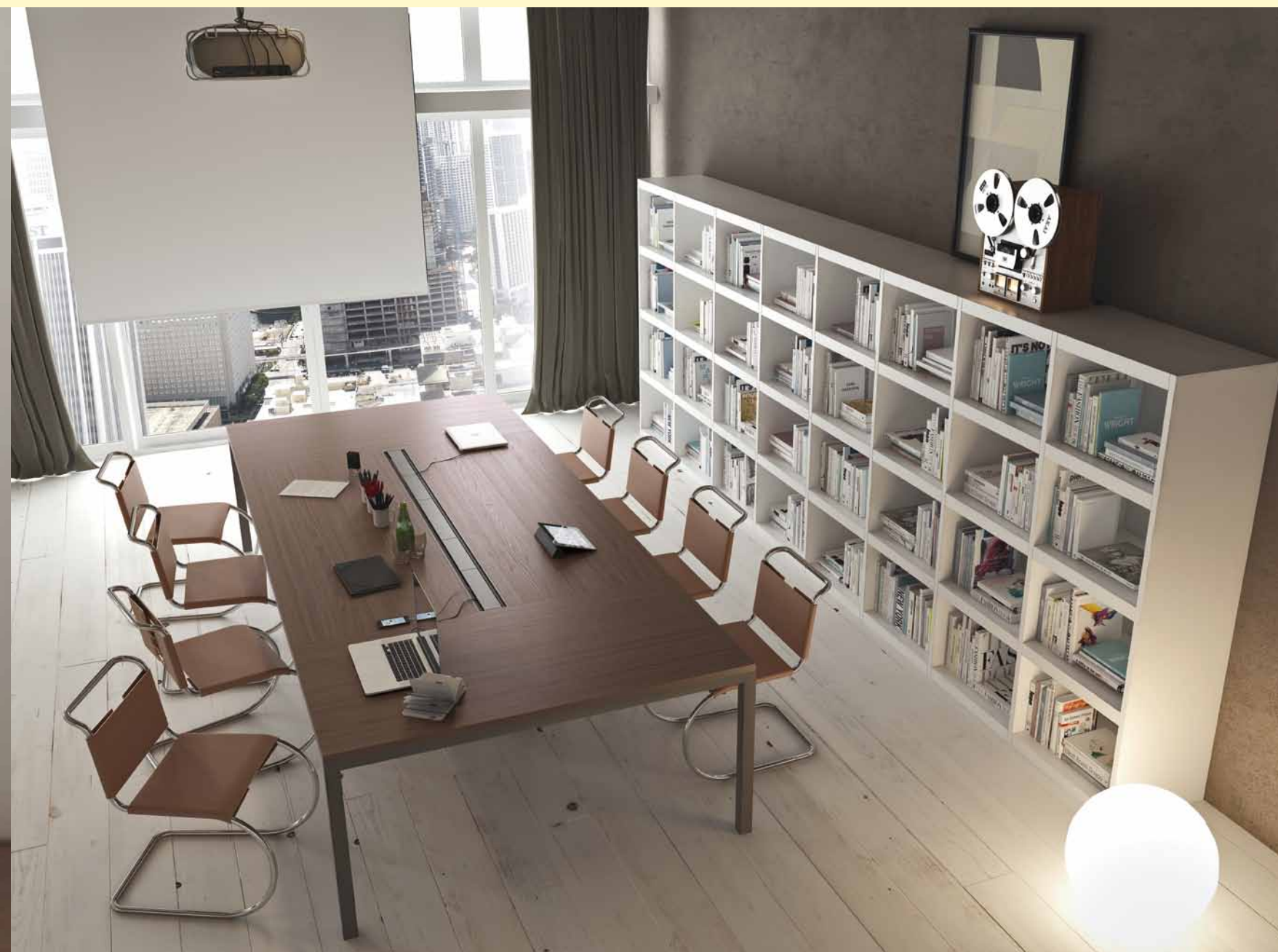

---

# yard MEETING

---

*Yard meeting table W. 3200 D. 1600 mm. Desktop in nocino melamine and leg titanio lacquered colour. Central flip top for cable management in titanio lacquered colour.*

*Tavolo riunioni Yard L. 3200 P. 1600 mm piano in melaminico nocino, gambe titanio.  
Flip top centrale titanio per passaggio cavi.*

*Table réunion Yard L. 3200 P. 1600 mm plateau en melamine nocino et pieds titanio. Flip top central titanio pour le passage de câbles.*





## sharingspace

*The meeting table system can be composed by central electrifiable columns that allow a complete use of the table surface.*

*Meeting table W. 3200 D. 1600 mm, composed by 2 tops and 2 pillar legs, and central flip top for cable passage.*

*Il sistema tavoli riunioni può essere realizzato con piantane centrali elettrificabili che permettono il totale utilizzo del piano.*

*Tavolo riunioni L. 3200 P. 1600 mm formato da 2 piani e 2 piantane e flip top centrale per passaggio cavi.*

*Le système de tables de réunion peut être réalisé avec pieds tulipes centraux électrifiables, qui permettent la totale utilisation du plateau.*

*Table de réunion L. 3200 P. 1600 mm composée par 2 plateaux et 2 pieds tulipes et flip top central pour le passage des cables.*



*imagine*  
**your space**



**10** × 

*Meeting table*  
W. 2400 D. 1200 mm

*Tavolo meeting*  
L. 2400 P. 1200 mm

*Table réunion*  
L. 2400 P. 1200 mm



**18** × 

*Meeting table*  
W. 4800 D. 1600 mm

*Tavolo meeting*  
L. 4800 P. 1600 mm

*Table réunion*  
L. 4800 P. 1600 mm





# yard with legs

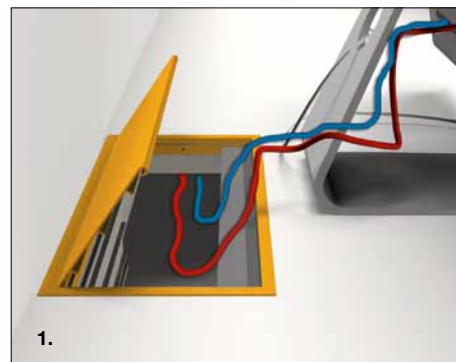
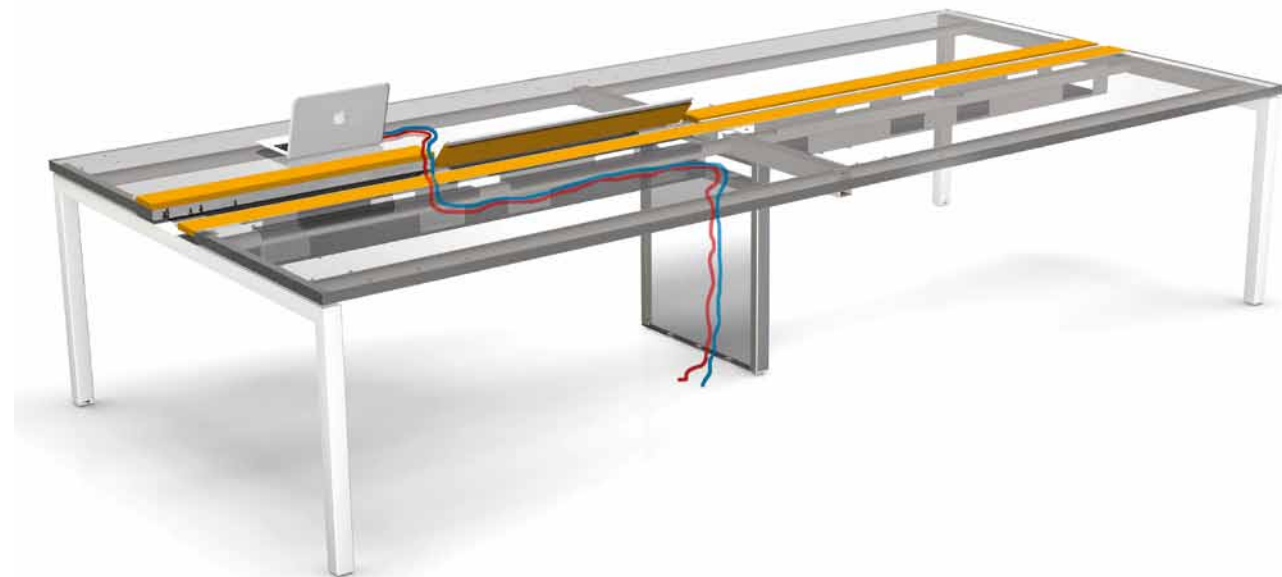

**1.** Different typologies of cable outlets available.

1. Sono disponibili diverse tipologie di passacavo.

1. Il y a différents types de passe-câbles.

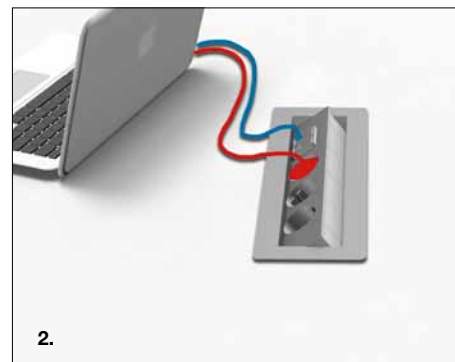

**2.** Turn motorized socket.

2. Ciabatta girevole motorizzata Turn.

2. Prise multiple motorisé Turn.

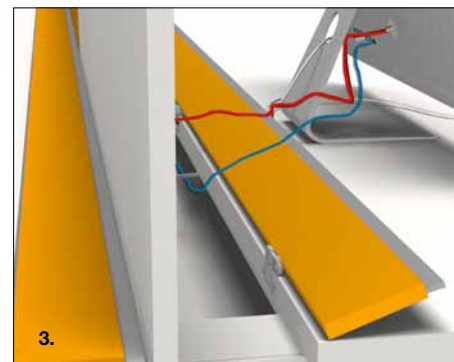

**3.** Flipper.

3. Flipper.

3. Flipper.

# yard with pillar legs

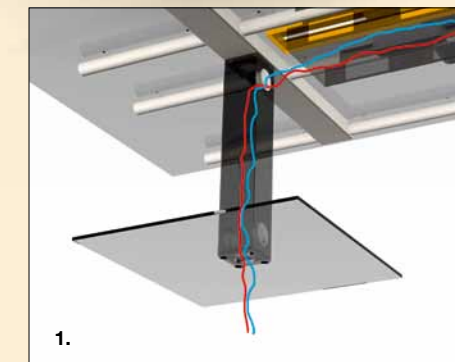
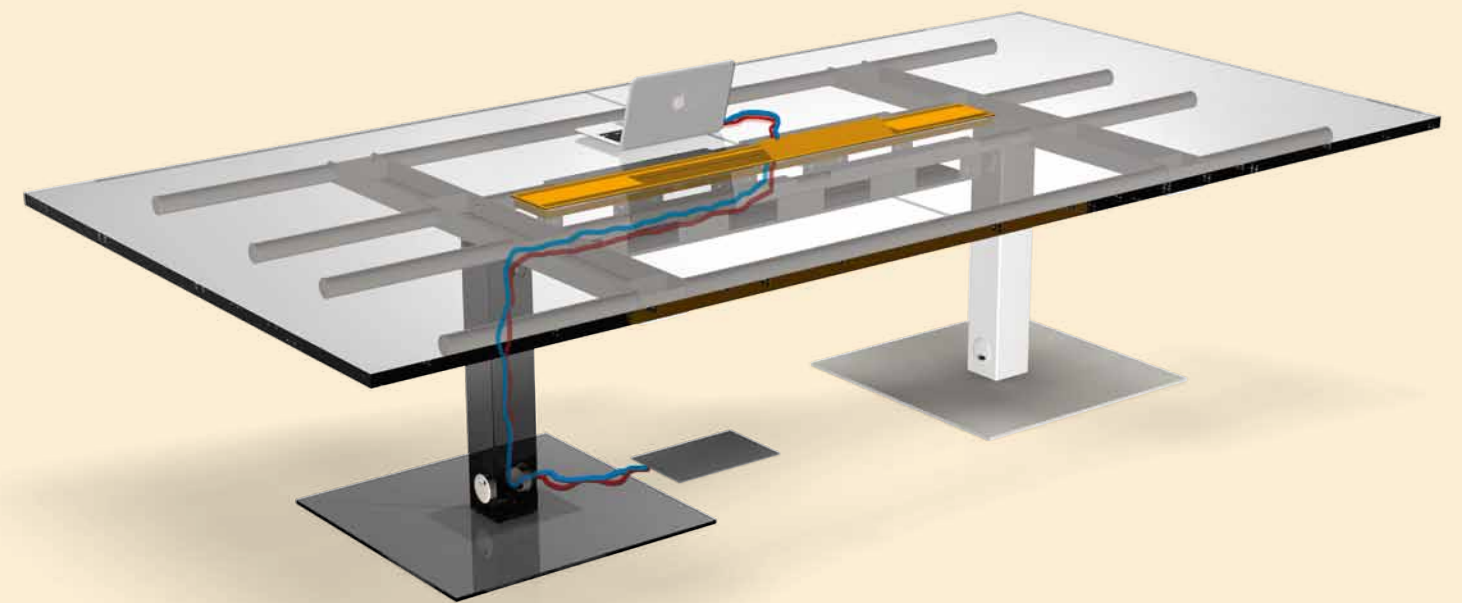

**1.** Column base with hole for cable passage.

1. Piantana con foro passacavi per passaggio cavi.

1. Pied tulipe avec trou passe-câbles.

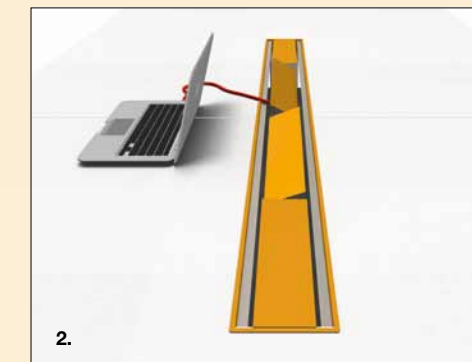

**2.** Desk top electrification through flip top.

2. Elettificazione sopra piano tramite flip top.

2. Electrification par le flip top.



# sound absorption



frontal screen

cabinet back



**1.** Fabric cat. C, D, F: fabric improves soundproof performance of the internal panel.

**2.** Acoustic Panel composed by melamine board 18 mm th. with specific linear perforation, designed to create a balanced environmental acoustic.

The fabric upholstery (Cat. C-D-F) personalizes the product and improves its sound-proof performance.

**\* Available for projects only**

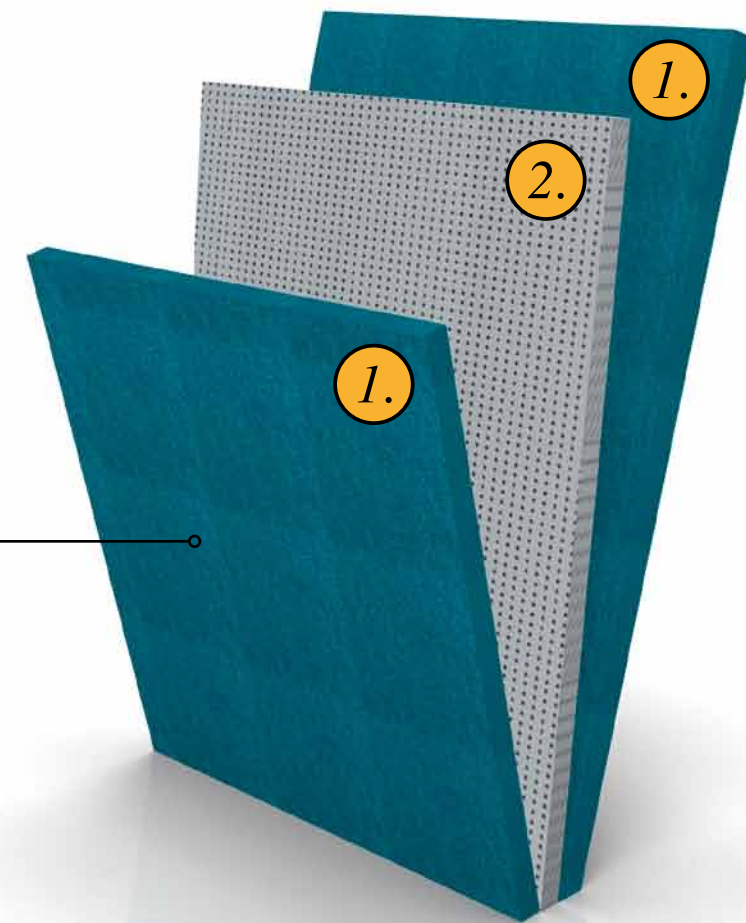

## 95% less noise 20% more productivity

**1.** Tessuto cat. C-D-F: il tessuto aumenta le prestazioni del pannello fonoassorbente interno. **2.** Pannello realizzato in MDF spessore 18 mm e dotato di specifica perforazione differenziata studiata per creare un'acustica ambientale equilibrata. Il rivestimento in tessuto (Cat. C-D-F) personalizza il prodotto e ne incrementa il potere fonoassorbente.

**\* Disponibile solo per progetti**

**1.** Tissu cat. C, D, F: le revêtement en tissu augmente le pouvoir phono-absorbant du panneau intérieur. **2.** Panneau réalisé avec MDF 18 mm d'épaisseur et équipé de spécifique forage différencié, conçue pour créer une acoustique environnemental équilibré. Le revêtement en tissu (Cat. C-D-F) personnalise le produit et augmente le pouvoir phono-absorbant.

**\* Disponible seulement pour les projets**



*The “Central Spine Systems”, that are those systems provided with a central element to whom the desks are connected perpendicularly, are here represented by the program Vertebra (spine) with Pigreco or Yard (desk). The most evident advantage that this work solution offers consists in the possibility of obtaining a high level of privacy and a very comfortable access to filing and use the skirting of the central spine to wire manage the cluster without necessarily using raised floors.*

*I sistemi a “Spina Centrale”, ovvero quei sistemi dotati di un elemento centrale al quale le scrivanie sono agganciate perpendicolarmente, sono rappresentate dal programma Vertebra (spina) con Pigreco o Yard (scrivania). Il vantaggio più evidente che offre questa tipologia di lavoro è rappresentato dalla possibilità di ottenere un alto livello di privacy con un’archiviazione a portata di mano, e la possibilità di sfruttare lo zoccolo della spina centrale per l’alloggiamento dei cablaggi, senza ricorrere a pavimenti flottanti.*

---

# pigreco-yard & vertebrasystem

---

*Les systèmes de «Spina Centrale», à savoir les systèmes avec un élément central auquel les bureaux sont accrochés perpendiculairement, sont représentés par le programme Vertèbra (spina) avec Pigreco ou Yard (bureau). L’avantage le plus évident qui offre ce type de poste de travail est représenté par la possibilité d’obtenir un niveau élevé de “privacy” avec l’archivage à portée de main, et la possibilité d’exploiter le socle du rangement central pour mettre le câblage, sans recourir à planchers flottants.*





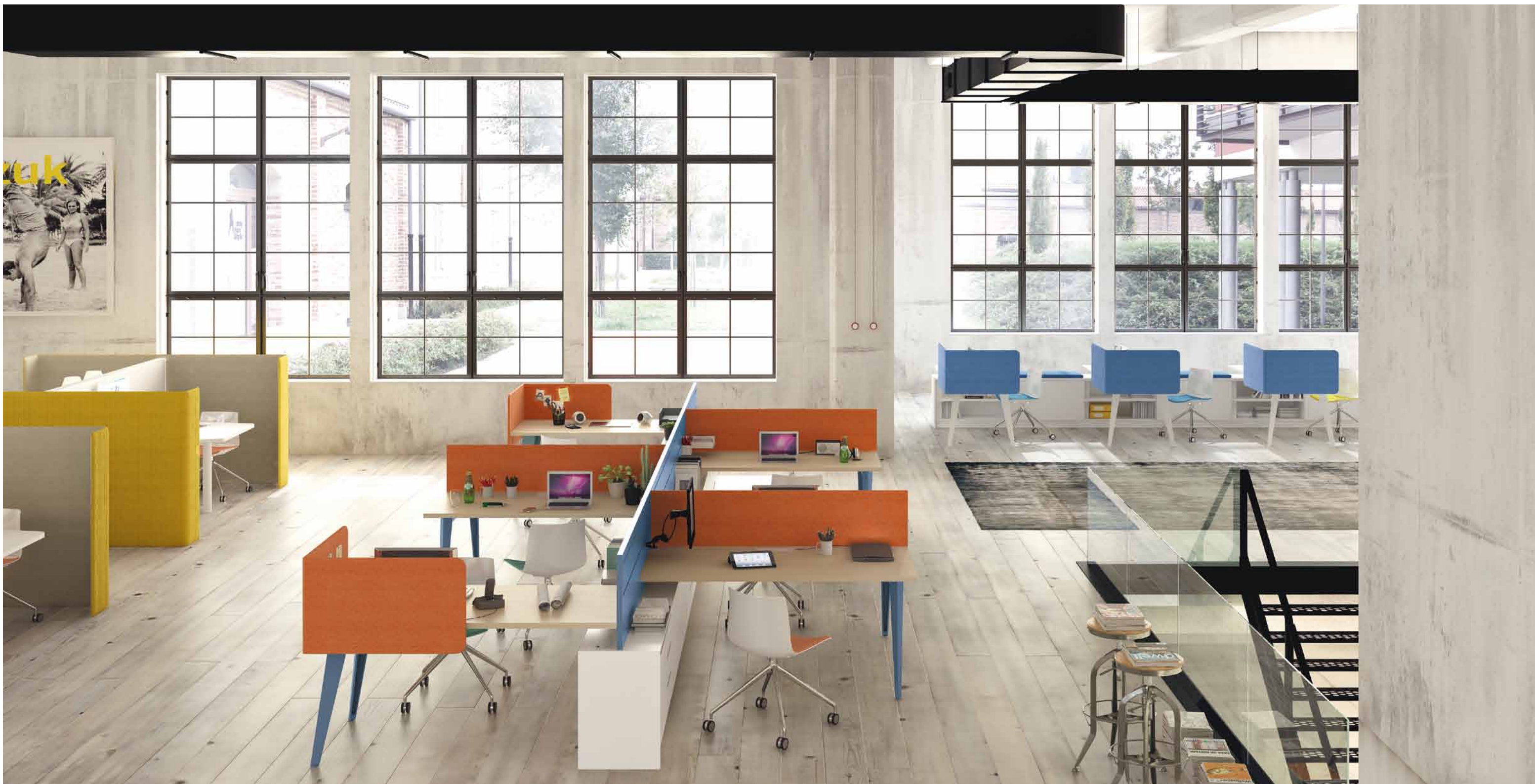

---

# vertebrasystem

---

*“Vertebra” double-sided for opposed workstations. On top of the “Vertebra” it has been fixed a screen panel of 30 mm thickness equipped with accessory rails for stationery and monitor arms that, other than improving the functionality, segregates the workspace and create privacy. The azzurro polvere color of the screen is linked to the legs of Pigreco desk. In the background Pod system.*





*“Vertebra” bifacciale per postazioni contrapposte. Sopra la “Vertebra” è stato posizionato uno screen sp. 30 mm con barre portaoggetti e portamonitor che, oltre a migliorare la funzionalità, suddivide lo spazio creando privacy. Il colore azzurro polvere dello screen è abbinato alle gambe delle scrivanie Pigreco. Sullo sfondo postazioni Pod.*

*Biface “Vertèbres” pour des positions contre-posées. Au-dessus de la “Vertèbre” a été placé un écran épaisseur 30 mm avec rails porte accessoires et porte-monitor qui en plus d’améliorer la fonctionnalité, divise l’espace et crée une privacy. La couleur de l’écran bleu poudre est couplé à les pieds des bureaux Pigreco. Dans les stations de fond: Pod.*











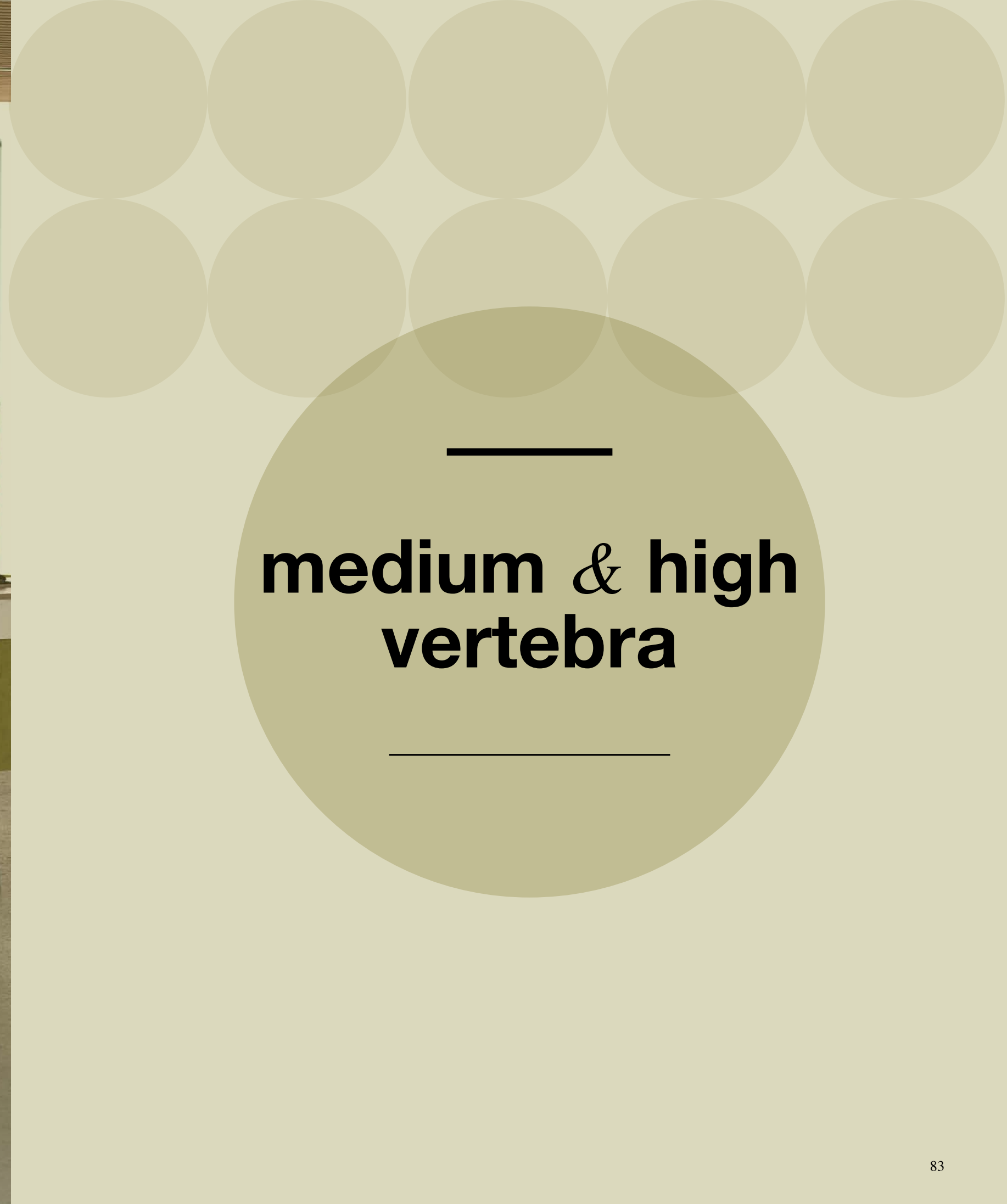

—  
**medium & high  
vertebra**  
—







---

# INSPIRATIONS *for project only*





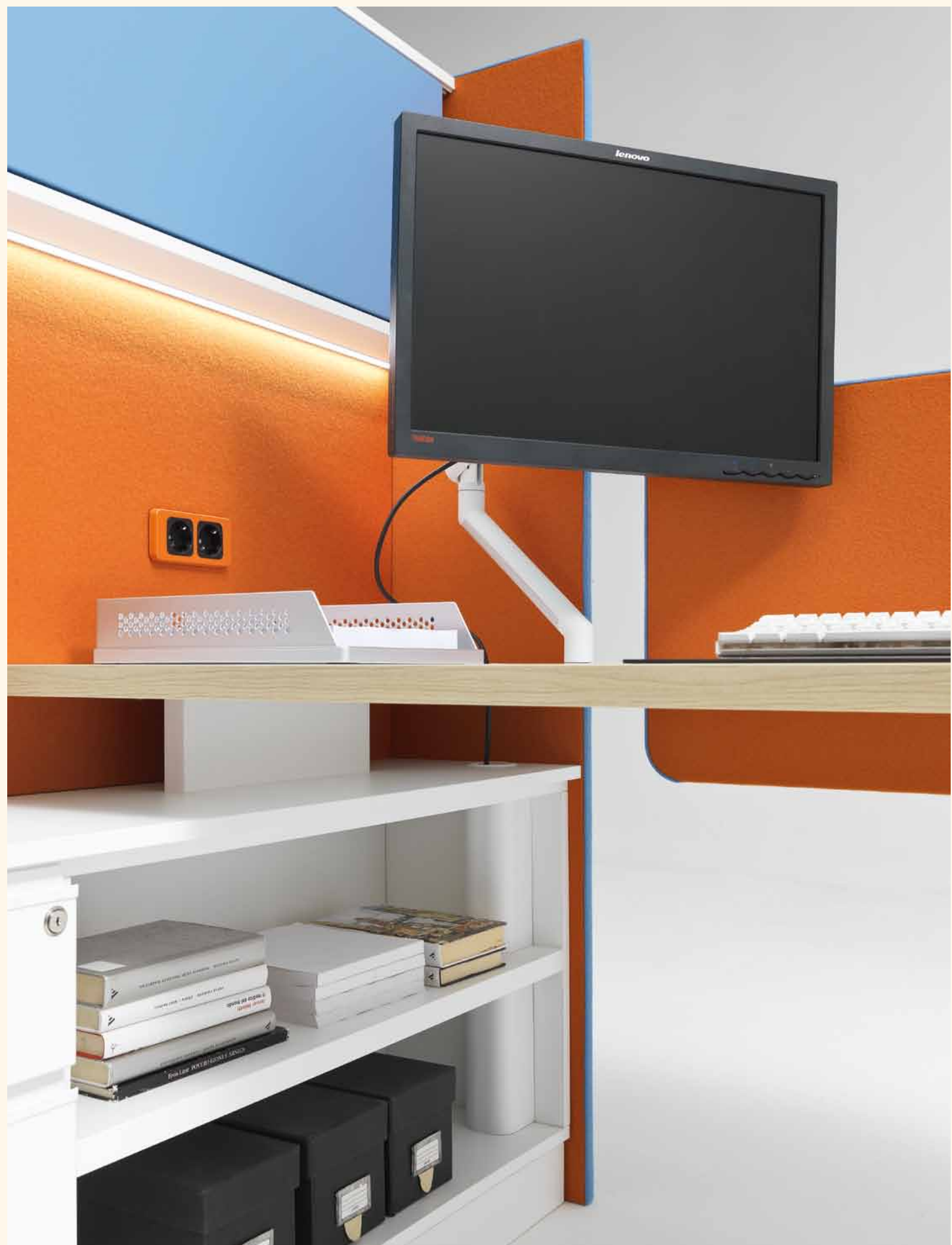

---

# shared<sup>spine</sup>

*Shared spine: one sided low opposite cabinets, double sided shared overhead storage.*

*Spina condivisa: contenitori bassi monofacciali contrapposti con sopra overhead bifacciali condivisi.*

*Spine contre-posée: meubles unifaces bas contre-posés et au-dessus meubles "overhead" deux faces partagés.*





# elements & dimensions

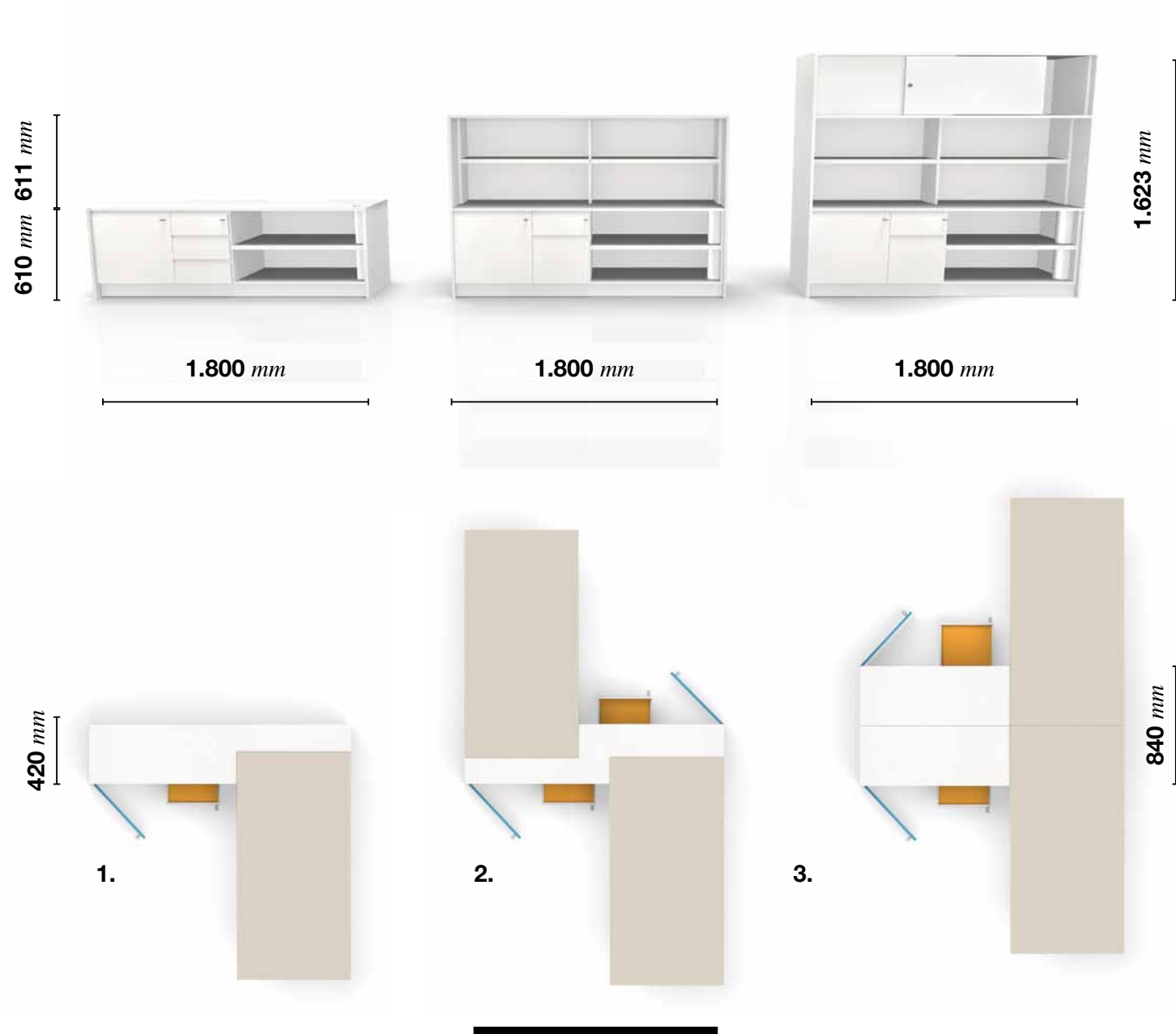

1. Single sided spine. 2. Double sided spine. 3. Double low spine.

1. Spina monofacciale. 2. Spina bifacciale. 3. Spina doppia.

1. Spine uniface. 2. Spine deux faces. 3. Spine double.

# performances

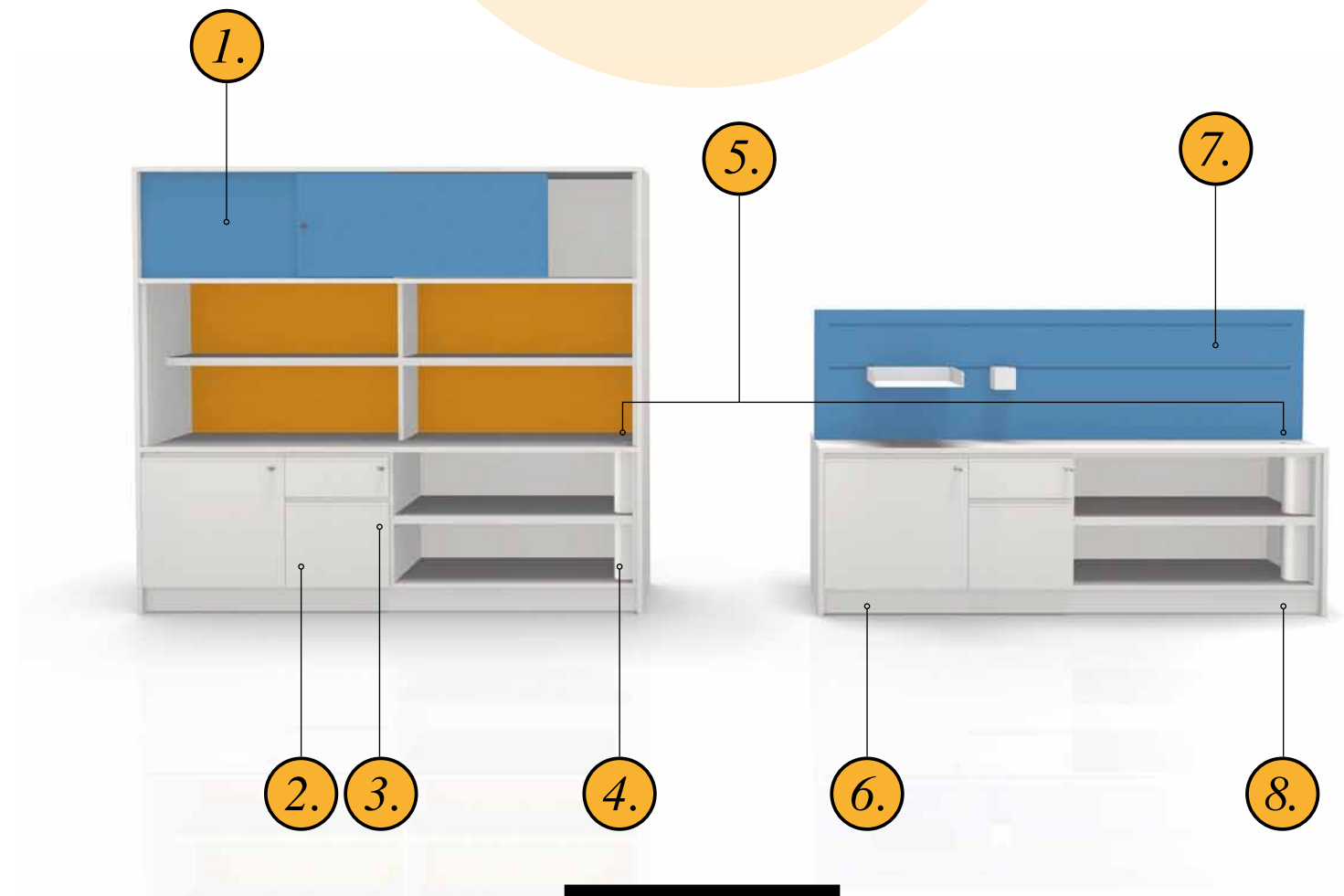

1. Preassembled storage frame with hardware installed. 2. Metal drawers. 3. Ball bearing glides, full extraction with soft closing and anti-tilting mechanism, centralized locking system, weight capacity of 30 Kg. 4. Metal cable-riser cover.

5. Hole for cables Ø60. 6. Height adjustable feet. 7. Screens. 8. Removable skirting for access to cable management.

1. Scocche dei moduli fornite premontate con ferramenta già applicata. 2. Cassetti metallici. 3. Guide a sfera, estrazione totale con sistema soft closing e anti-tilting, chiusura centralizzata, portata cassetto 30 kg. 4. Carter per salita cavi.

5. Foro passacavi Ø60. 6. Piedini regolabili. 7. Screens. 8. Zoccolo ispezionabile per accesso all'elettrificazione.

1. Structures de meuble livrés pré-assemblés avec ferrure appliqué. 2. Tiroirs en métal. 3. Glissières sur roulement à billes, extraction totale avec système anti-basculant et fermeture en douceur, verrouillage central, charge 30 kg. 4. Carter pour la remontée des câbles. 5. Obturateur Ø60. 6. Pieds réglables. 7. Cloisonettes. 8. Socle ouvrant pour l'accès à l'électrification.

1. Structures de meuble livrés pré-assemblés avec ferrure appliqué. 2. Tiroirs en métal. 3. Glissières sur roulement à billes, extraction totale avec système anti-basculant et fermeture en douceur, verrouillage central, charge 30 kg. 4. Carter pour la remontée des câbles. 5. Obturateur Ø60. 6. Pieds réglables. 7. Cloisonettes. 8. Socle ouvrant pour l'accès à l'électrification.





---

## *cable* **management**

---

*Cables run along the skirting and exit through the grommet.*

*L'elettrificazione corre lungo lo zoccolo ed esce attraverso il foro passacavi.*

*Les câbles passent le long du socle et sortent par le trou passe-câbles.*

---

# THE FUNCTIONALITY OF **pod***partition*

---

*POD è il sistema Martex dedicato alla creazione di spazi lavoro dove sia richiesta un'elevata concentrazione e aree di incontro e di comunicazione, separate visivamente ed acusticamente dall'open space. La struttura di POD è composta da una parete TE, con elettrificazione integrata, abbinata a pannelli realizzati in resina espansa e rivestiti di tessuto che possiedono sia un alto potere fonoassorbente, sia la resistenza al fuoco in classe 1.*

*POD est le système Martex dédié à la création d'espaces où les travaux nécessitant une grande concentration et salles de réunion-communication, séparés visuellement et acoustiquement de l'espace ouvert. La structure de la POD est composé d'une paroi TE, avec électrification intégrée, combinée avec des panneaux en résine élargi et rembourage en tissus qui possèdent à la fois d'un fort pouvoir d'absorption du son et une résistance au feu en classe 1.*



*POD is the Martex system dedicated to creation of workplaces where it is required a high level of "focus" and meeting or communication areas provided with acoustic and view separation from the open space. POD's frame is composed by TE partition, with integrated electrification, in combination with panels realized in foam and upholstered in fabric with high sound-absorption characteristics and class 1 fire resistance.*



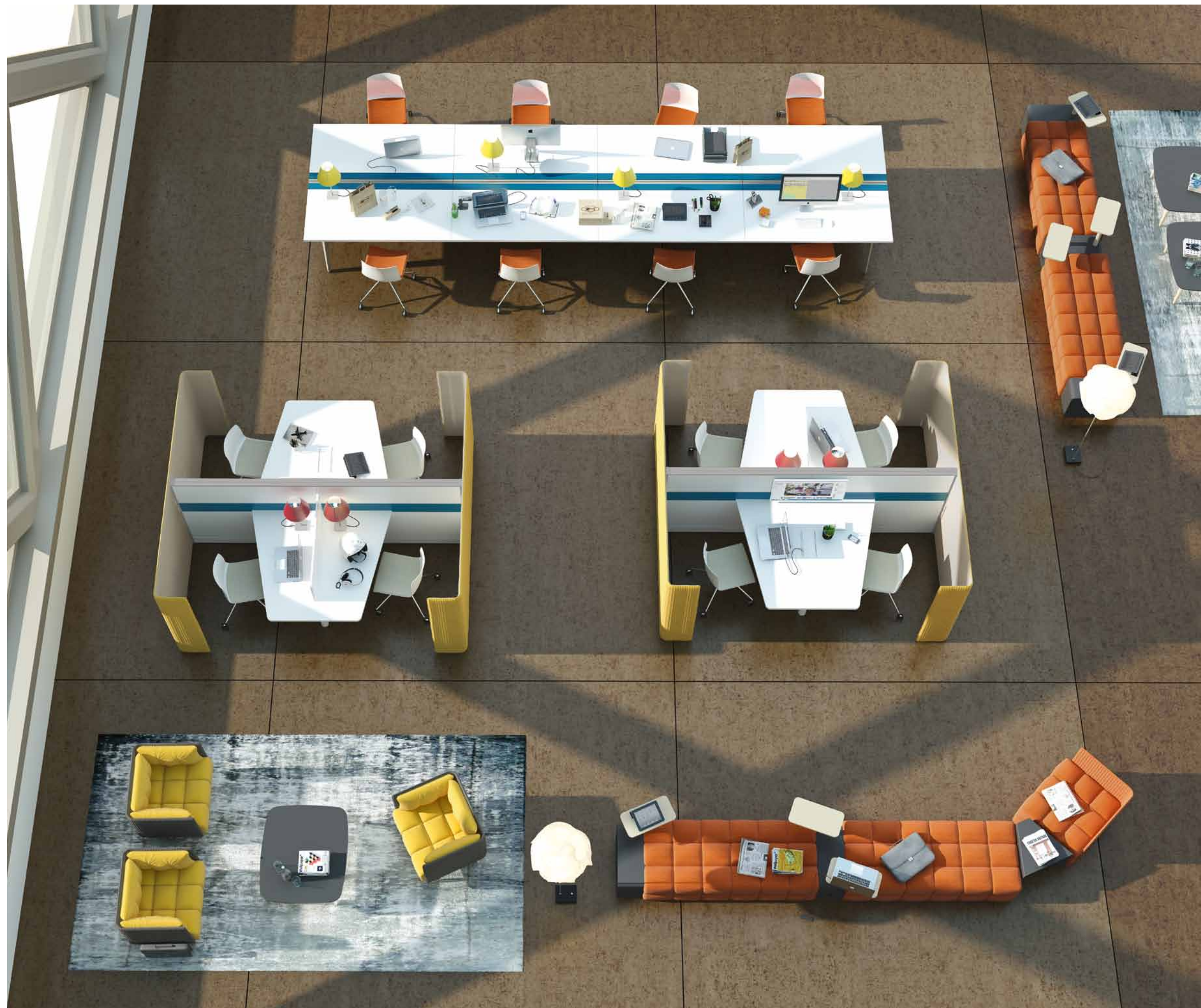

---

# socialize, team working & communication

*Common areas may appear as spaces out from the intensive and routine work: reality is the opposite. Huddle rooms, activity rooms, multipurpose tables, coffee area, pods, war room, lounge areas are the new places of the contemporary office where the knowledge workers express themselves. They are informal areas, often with “home spirit” created to facilitate communication and interaction among people. Such places allow to overcome the hierarchical rules and foster spontaneous expression that frequently generates interesting original and alternate points of view.*

*Ad una analisi superficiale le aree comuni possono apparire come spazi sottratti al lavoro intensivo e routinario: la realtà è diametralmente opposta. Huddle room, activity rooms, multipurpose tables, coffee area, pods, war room e lounge areas sono i nuovi luoghi dell'ufficio contemporaneo dove si esprimono i knowledge worker. Sono aree informali, spesso con riferimenti “domestici” che nascono per favorire la comunicazione e l'interazione tra le persone. Questi, a volte, permettono di superare anche le regole gerarchiche e consentono una espressione libera e spontanea che, frequentemente, ha offerto spunti di riflessione che si sono rivelati originali ed alternativi.*

*Lors d'une analyse superficielle les zones comunes peuvent apparaître comme des espaces soustraits au travail intensif et de routine: la réalité est diamétralement opposée. Salle Huddle, salles d'activités, tables polyvalentes, zone café, de dosettes, salle de la guerre et lounge sont les nouveaux lieux de bureau contemporain où le knowledge workers vont s'exprimer. Ces sont de zones informelles, souvent avec des références «domestique» nés pour favoriser la communication et l'interaction entre les gens. Ceux-ci, parfois, permettent de surmonter même les règles hiérarchiques et de permettre l'expression libre et spontanée qui, souvent, a fourni des points de réflexion originaux et alternatifs.*

---





*Composition suitable for individual work - with 2 opposed workstations and front screen - or for occasional meetings with wire managed meeting table, all in melamine white.*

*POD panels in pure new wool giallo 3D. Internal side with smooth pure new wool in tortora colour. TE panels in melamine white and azzurro polvere lacquered colour.*

*Composizione sia per lavoro individuale - con 2 posti di lavoro contrapposti e screen centrale - sia per brevi meeting - con tavolo riunioni elettrificato, tutto in melaminico bianco. Pannelli POD in tessuto CAT. M 100% pura lana 3D, interno liscio in 100% pura lana tortora. Pannelli Te melaminico bianco e laccato azzurro polvere.*



*Composition en mélamine blanc pour travail individuel avec 2 postes de travail et cloisonettes centrale ou pour réunion avec table réunion avec électrification. Panneaux POD en pure laine vierge giallo 3D, intérieur lisse en pure laine vierge tortora. Panneaux Te en mélamine blanc et laqué azzurro polvere.*







**pod**partition

---

# podcollaboration

*Pod composition H. 1700 W. 2880 mm that allows, in large open space, to create shared workspaces, yet reserved.*

*Composizione Pod H. 1700 L. 2880 mm che permette, in grandi open space, di creare aree di lavoro condivise ma allo stesso tempo riservate.*

*Composition Pod H. 1700 L. 2880 mm qui permet, dans des grands open spaces, de créer des espaces de travail partagés et en même temps réservés.*





*imagine*  
**your space**

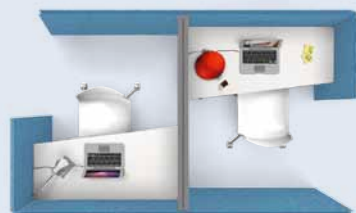
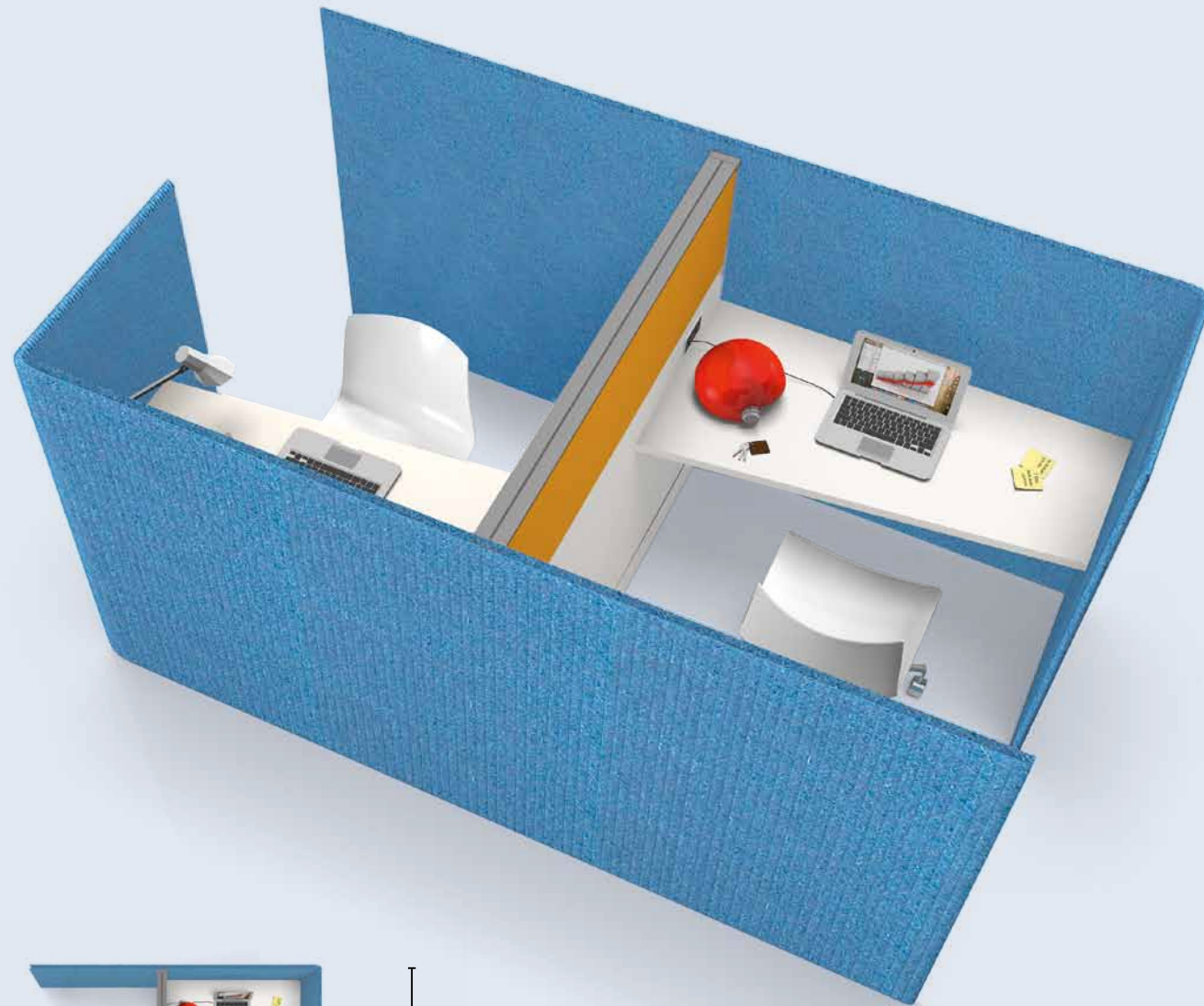

2560 mm

1480 mm

**2** × 

**podpartition**

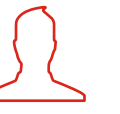
**3** × 



4320 mm



1320 mm

700 mm

*imagine your space*



2 × 

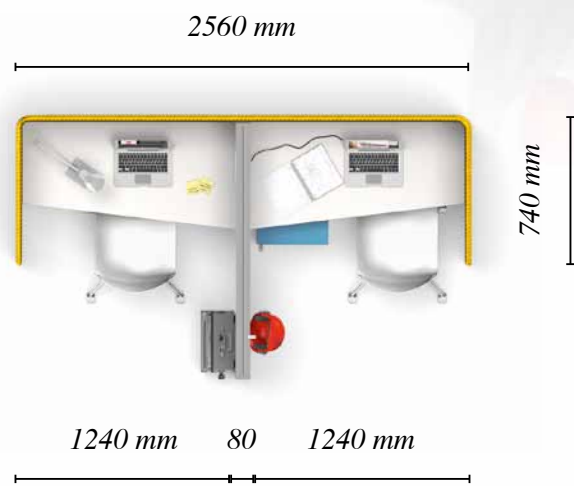

4 × 

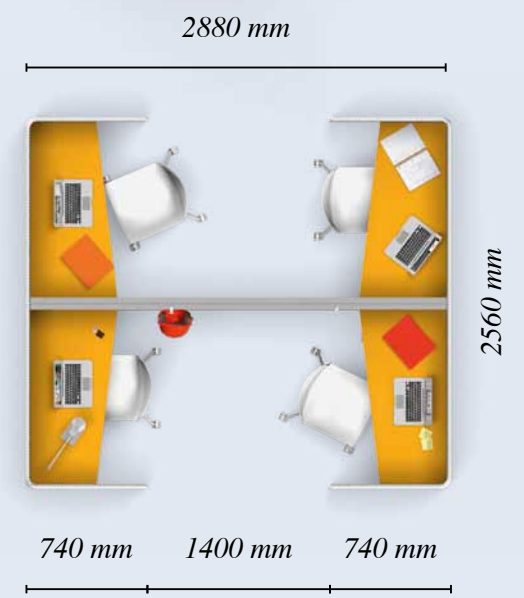



# technical details



*A strong frame, easy to assemble and easy to cable manage.*

*Una struttura forte, semplice da montare, facile da cablare.*

*Une structure solide, facile à assembler, facile à câbler.*

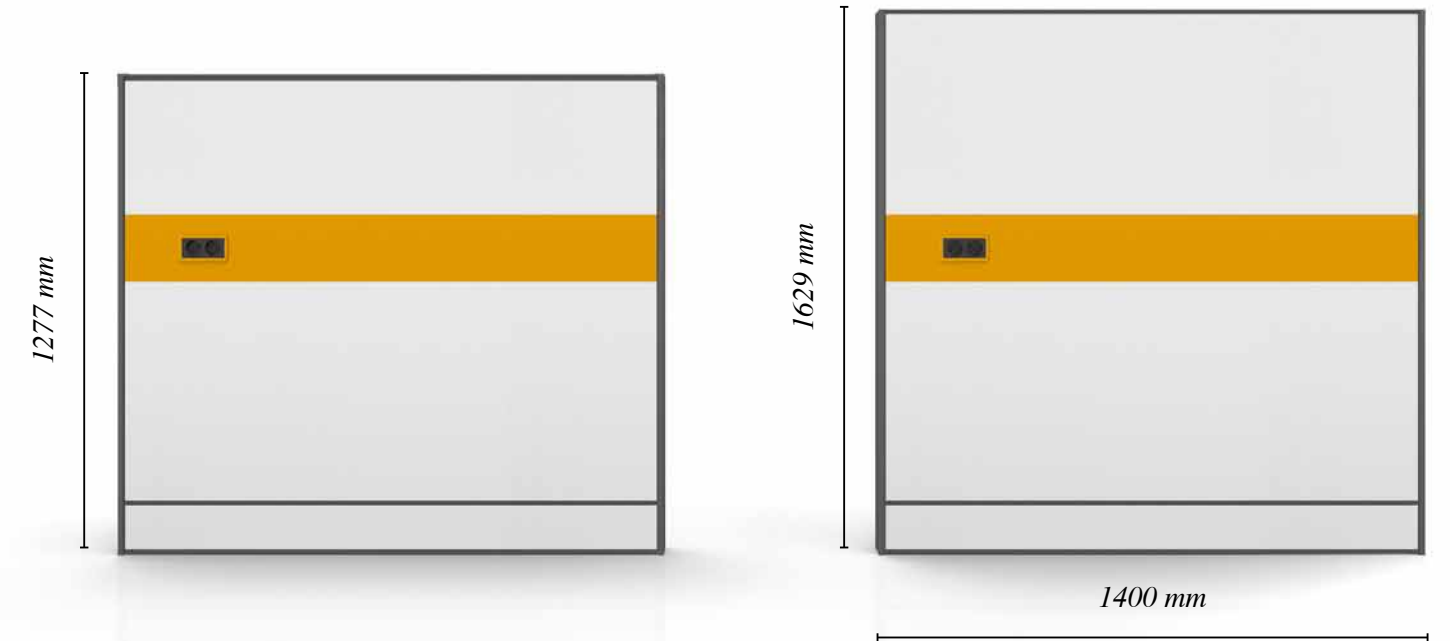

*Panels available in melamine, matt lacquered, fabric, writable melamine.*

*Pannelli disponibili in melaminico, laccato opaco, tessuto, melaminico scrivibile.*

*Panneaux disponibles en mélamine, laqué mat, tissu, mélamine inscriptible.*

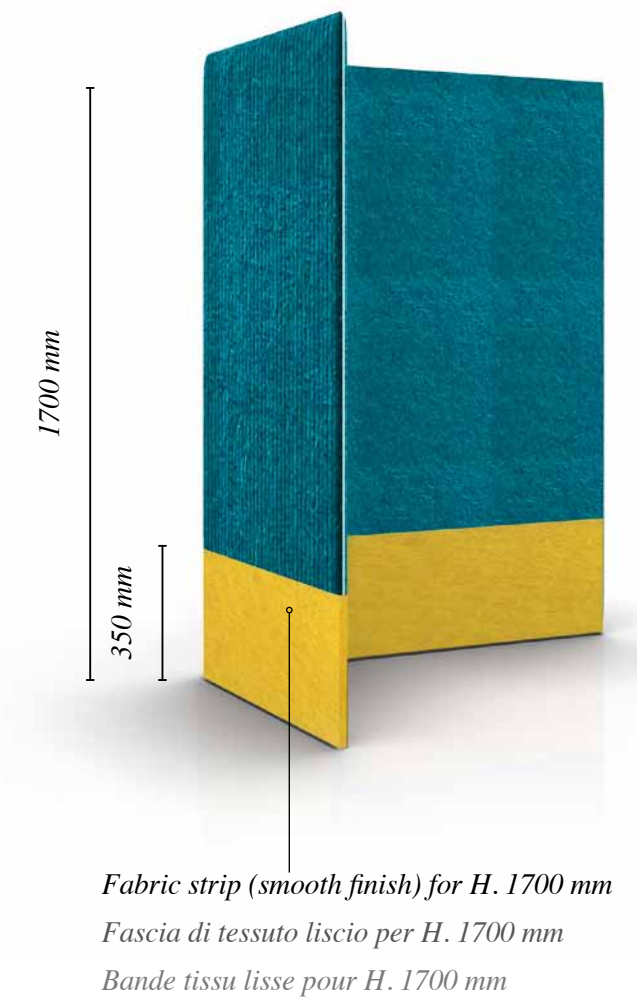



# sound absorption for podpartition

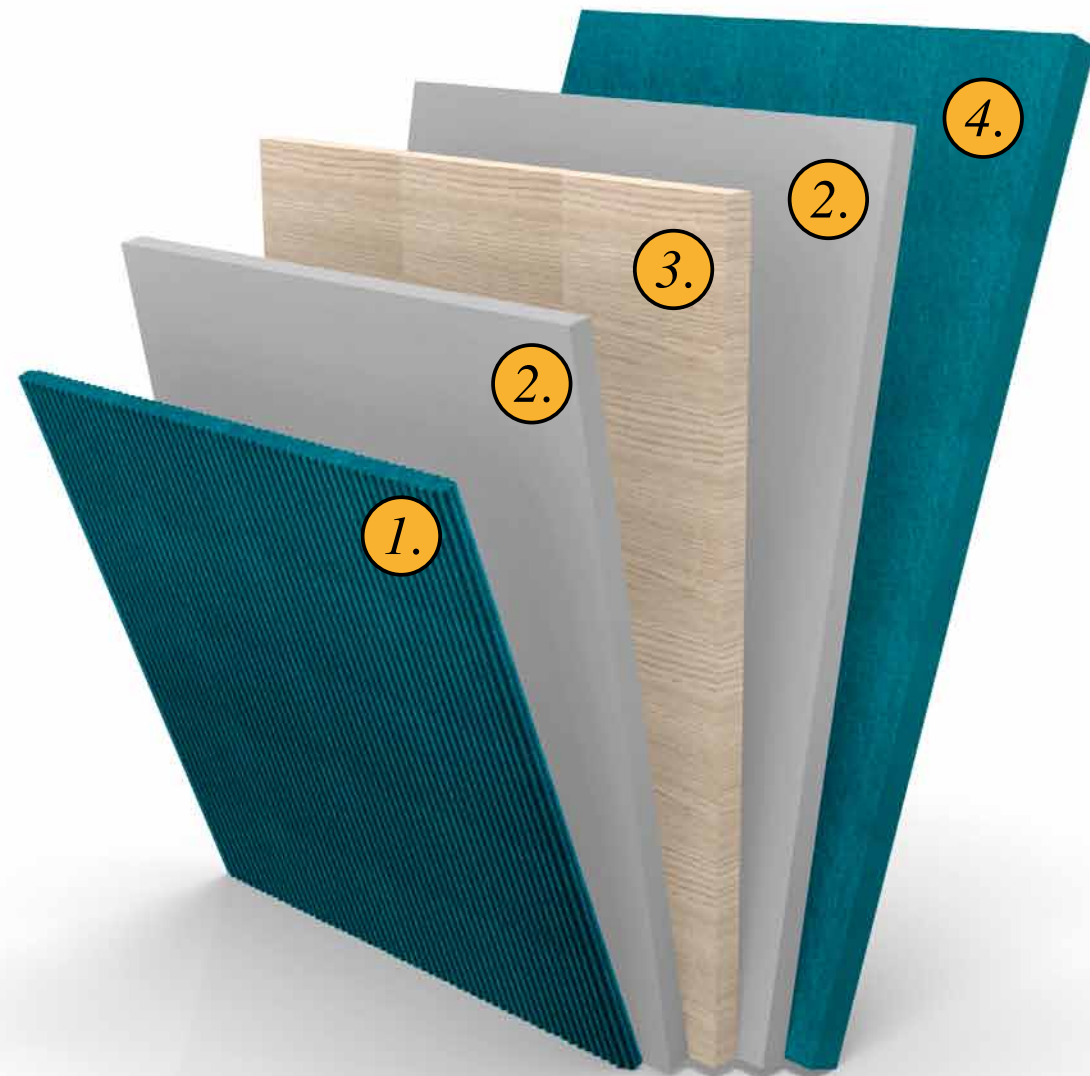

**1.** External thermoformed panel in stretchy 3D, pure new wool 3D. **2.** Acoustic panels in elastic foamed resin with completely opened cells fire resistant. **3.** Multilayer th. 18 mm. **4.** Internal fabric in pure new wool, or stopfire.

**1.** Tessuto termoformato esterno in stretchy 3D o 100% lana 3D. **2.** Pannelli acustici in resina espansa a celle aperte con resistenza al fuoco. **3.** Multistrato sp. 18 mm. **4.** Tessuto interno in 100% lana, o stopfire.

**1.** Tissu thermoformé externe stretchy 3D ou laine bouillie 3D. **2.** Panneaux acoustiques mousse de résine à cellules ouvertes ayant une résistance au feu. **3.** Multicouche épaisseur 18 mm. **4.** Doublure en laine bouillie, ou stopfire.

# acoustic performances

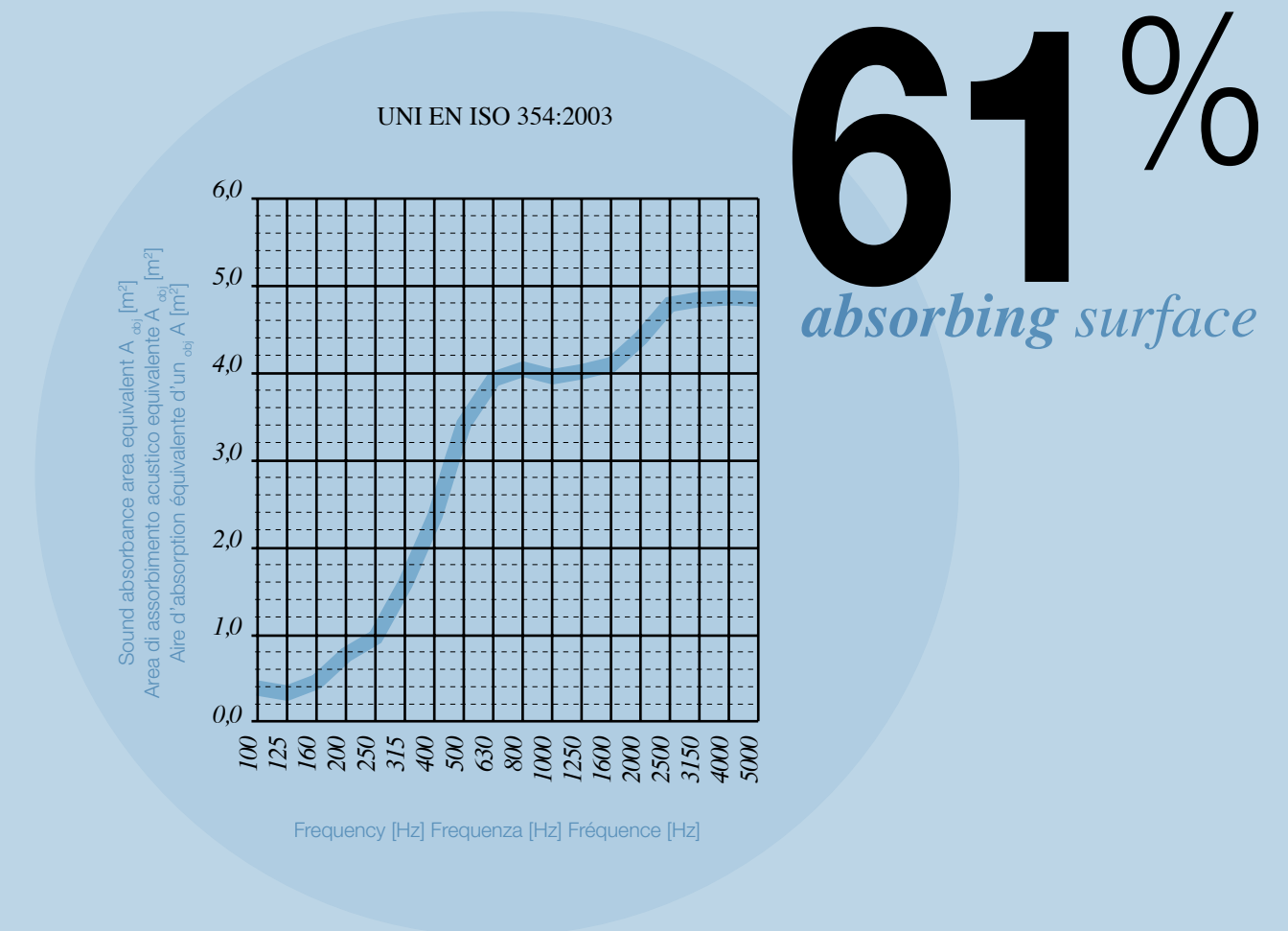

The product has, at typical frequencies of speech (between 500 Hz and 2000 Hz), an average value of area of absorbance equivalent to approximately 4 m<sup>2</sup>, that equals to about 61% of absorbance area than the total panel surface, having considerable advantages of reverberation time in the environment where it is installed.

Il prodotto presenta, nelle frequenze tipiche del parlato (tra i 500 Hz e i 2000 Hz) un valore medio di area di assorbimento equivalente pari a circa 4 m<sup>2</sup>, che equivale a circa il 61% di area assorbente rispetto all'area totale del pannello, con notevoli vantaggi in termini di tempo di riverberazione all'interno dell'ambiente in cui verrà installato.

Aux fréquences moyennes (entre 500 Hz et 2000 Hz), le produit a un valeur moyenne de zone d'absorption équivalent d'environ 4 m<sup>2</sup>, ce qui correspond à environ 61% de l'aire d'absorption par rapport à la surface totale du panneau, avec des avantages considérables en termes de réverbération dans le lieu où il est installé.





---

## *socialize areas &* **commonsplaces**

*Office is like a big city with its busy streets, the center always congested, the typical noise, while the common areas are like parks and gardens: a small oasis where people enjoy to meet and drink a coffee, talk freely or read something interesting because not everything happens on your desk and personal enrichment involves listening, dialogue and confrontation.*

*Un ufficio è come una grande città con le sue strade trafficate, il centro sempre congestionato, i suoi rumori - talvolta assordanti e le aree comuni sono come i suoi parchi e giardini: piccole oasi dove le persone si incontrano per bere un caffè, parlare liberamente o per leggere qualcosa di interessante perché non sempre tutto avviene sopra la propria scrivania e l'arricchimento personale passa attraverso l'ascolto, il dialogo ed il confronto.*

*Un bureau est comme une grande ville avec ses rues animées, le centre toujours congestionné, ses bruits parfois assourdissants et les espaces communs sont comme ses parcs et jardins: une petite oasis où les gens se réunissent pour boire un café, parler librement ou lire quelque chose d'intéressant parce que tout ne se passe dessus de votre bureau et l'enrichissement personnel passe par l'écoute, le dialogue et la confrontation.*

---







---

# internetpoint & romi

---



*The Romi stools allow creating informal work areas or comfortable coffee break corners so to create pleasant zones dedicated to socialize.  
\* See Complements catalogue and pricelist.*

*Gli sgabelli Romi permettono di creare delle informali aree lavoro o dei confortevoli angoli per la pausa caffè; si creano così piacevoli zone dedicate alle relazioni sociali dell'azienda. \* Vedi catalogo e listino Complements.*

*Les tabourets Romi permettent la création du poste de travail informel ou des coins confortables pour la pause café; la création de zones agréables dédiés aux relations sociales de l'entreprise. \* Voir le catalogue et tarif Complements.*





---

# socializetime

*The aim of Martex is to improve the office environment by giving particular attention to employees' wellness through a creation of dynamic and creative "living spaces". In one place, we may find relax areas, spaces to share ideas, workplaces, and creative space or break areas.*

---

*L'obiettivo di Martex è quello di rendere migliore il luogo di lavoro, ponendo particolare attenzione al benessere dei dipendenti tramite la creazione di spazi "domestici", dinamici e creativi. In una stessa area troviamo aree relax, spazi per la condivisione delle idee, spazi di lavoro creativo e aree break.*

*Le but de Martex est de rendre meilleur le lieux de travail, en accordant une attention particulière au bien-être des employés avec la création des espaces «domestique», dynamique et créative. Dans la même zone, nous trouvons des espaces de détente, des espaces de partage des idées, des espaces de travail créatifs et les aires de repos.*



sharingspace







---

# sharing SPACE

---

*On left side: Hot desk W. 2700 H. 1600 mm Cat. B faux-leather 3D muschio with ocre lacquered top.*

*Above: Inattesa sofa Cat. A Stretchy 3D grigio scuro, with seat Cat. D Stopfire verde pistacchio.*

*\* See catalogue and pricelist Complements.*

*A sinistra: Hot desk L. 2700 H. 1600 mm Cat. B ecopelle 3D color muschio con piano laccato ocre.*

*Sopra: Divanetti Inattesa Cat. A Stretchy 3D grigio scuro, abbinato a seduta Cat. D Stopfire color verde pistacchio. \* Vedi catalogo e listino Complements.*

*Gauche: Hot desk L. 2700 H. 1600 mm Cat. B similcuir 3D muschio avec plateau laqué ocre.*

*Dessus: Inattesa canapé Cat. A Stretchy 3D grigio scuro, avec siège Cat. D Stopfire verde pistacchio.*

*\* Voir le catalogue et tarif Complements.*





## work in progress

*The Connect module, here combined with the Inattesa pouf, allows you to work and, at the same time have power supply. It is available in three different versions for better work functions.*

*\*See Complements catalogue and pricelist.*

*Il modulo Connect, qui abbinato ai pouf Inattesa, permette di lavorare e, contemporaneamente, disporre di prese di corrente. È disponibile in tre diverse versioni per una migliore ergonomia di utilizzo.*

*\*Vedi catalogo e listino Complements.*

*Module Connect, ici combinée avec la série de pouf Inattesa, permet de travailler et, dans le même temps, d'avoir des branchements. Il est disponible en trois versions différentes pour une meilleure ergonomie dans l'utilisation. \*Voir le catalogue et tarif Complements.*





*Imagine decorating your office as you always wanted. Martex collections, thanks to the variety and range of finish, allow a total customization according to your requirements of space and taste. Here we offer just a few ideas that can help you to find your office solution.*

*Immagina di arredare il tuo ufficio come hai sempre desiderato. Le collezioni Martex, grazie alla varietà di gamma e finitura, permettono una totale personalizzazione in base alle tue esigenze di spazio e di gusto. Qui proponiamo solo alcune idee che ti possono aiutare a trovare la tua soluzione d'arredo.*

—  
*imagine*  
**your space**  
—

*Imaginez de décorer votre bureau comme vous avez toujours désiré. Les collections de Martex, grâce à la variété de gamme et finition, permettent une personnalisation totale en fonction de vos exigences d'espace et de goût. Nous vous proposons ici seulement quelques idées qui peuvent vous aider à trouver votre solution.*





# — pigreco

2 x 

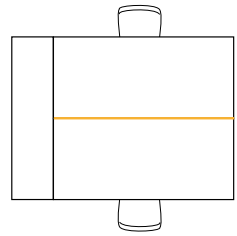

4 x 

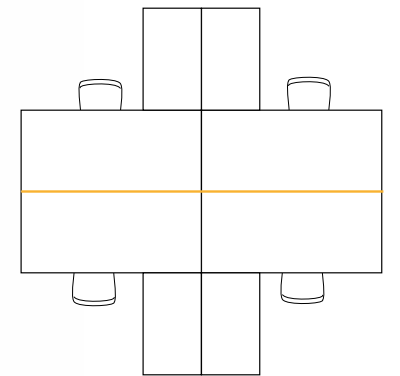

  
manyspace

4 x 

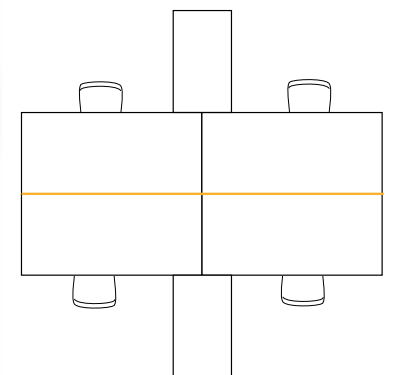



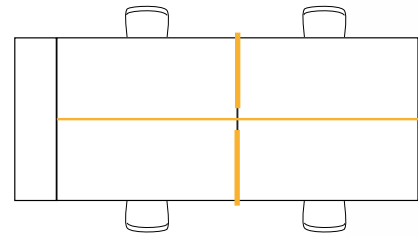

# — pigreco

4 × 

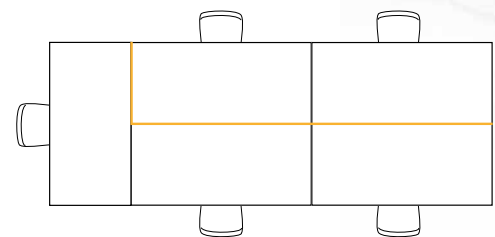

5 × 



6 × 

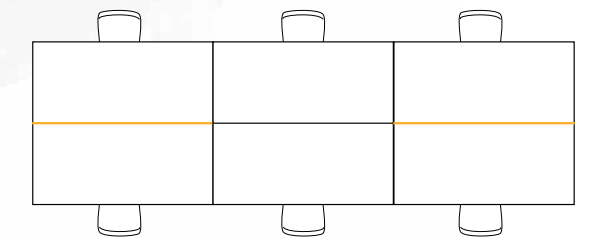

8 × 

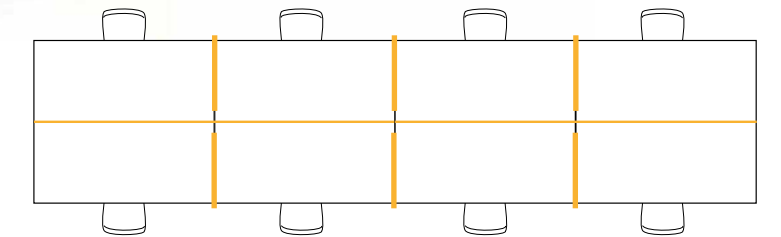



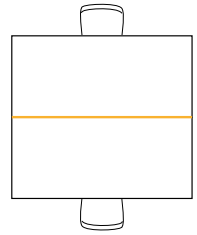

# yard

2 x 

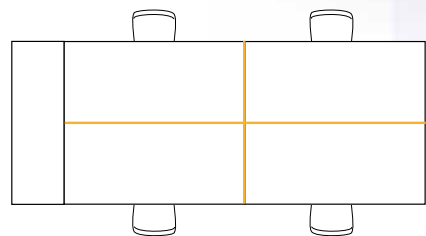

4 x 



8 x 

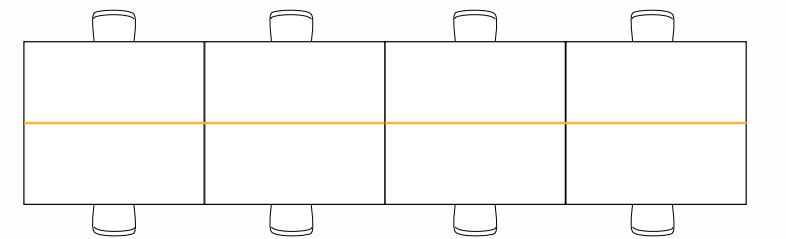



# vertebra

2 x 

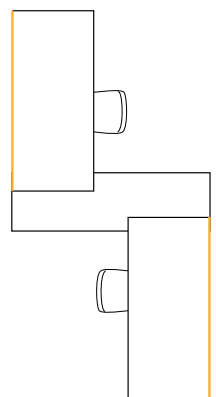

4 x 

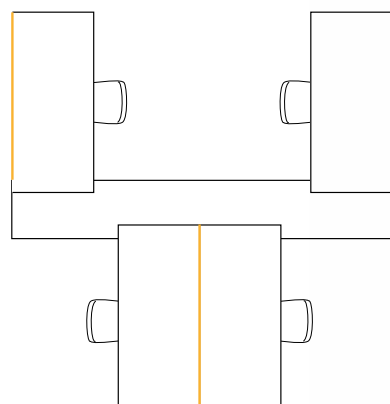

4 x 

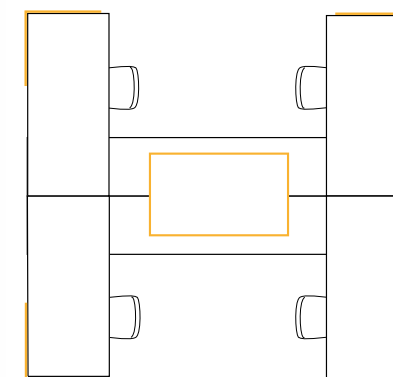

4 x 

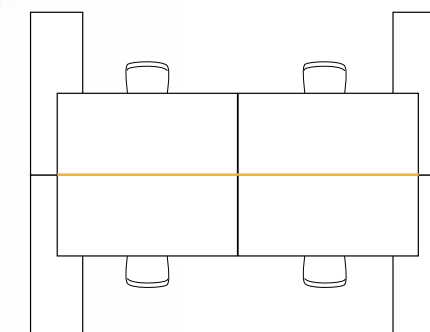



# vertebra

4 × 

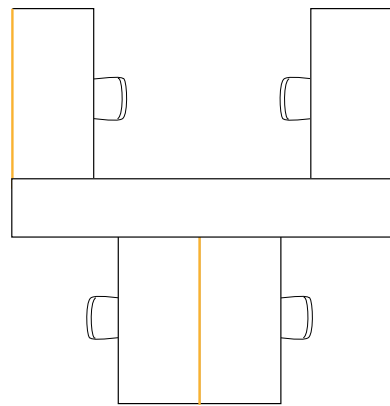

4 × 

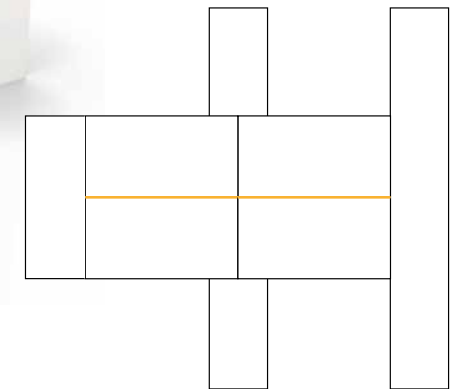

12 × 

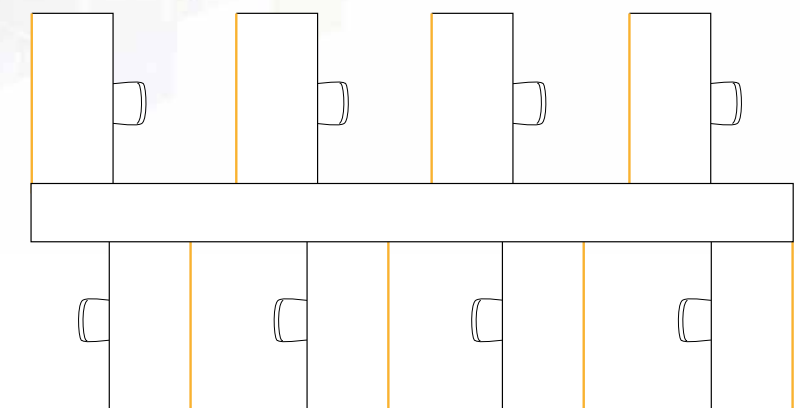



---

**pigreco  
& yard**  
COMMON  
ELEMENTS

---

---

**screen**

---

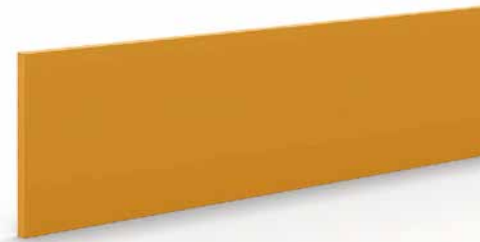

**Fixed screen th.18 mm**  
Screen fisso sp.18 mm  
Cloisonette fixé ép.18 mm

**W/L/L**  
1400-1600-1800



**Fixed screen th.30 mm**  
Screen fisso sp.30 mm  
Cloisonette fixé ép.30 mm

**W/L/L**  
1400-1600-1800



**Freestanding screen th.18 mm**  
Screen freestanding sp.18 mm  
Cloisonette freestanding ép.18 mm

**W/L/L - 800**



**Movable fabric screen**  
Screen Movable in tessuto  
Cloisonette Movable en tissu

**W/L/L - 900**



**"L" shape fabric screen**  
Screen ad "L" in tessuto  
Cloisonette d'angle en tissu

**W/L/L - 800**  
**D/P/P - 800**



---

# lateral storage

---



**Cabinet with hinged doors**  
Contenitore con ante battenti  
Meuble avec portes battantes

W/L/L - 800  
H/H/H - 720



**Cabinet with hinged doors**  
Contenitore con ante battenti  
Meuble avec portes battantes

W/L/L - 800  
H/H/H - 1070

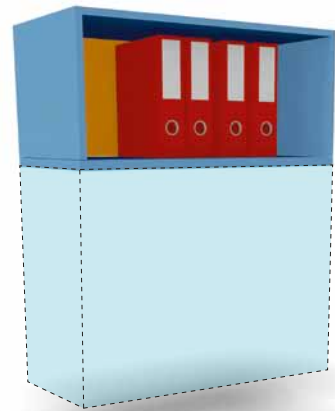

**Box with back**  
Box a giorno con schiena  
Box ouvert avec dos

W/L/L - 800  
H/H/H - 351

---

# under desk pedestals

---



**Metal pedestal on castors**  
Cassettiera metallica su ruote  
Caisson metallique avec roulettes

W/L/L - 422  
H/H/H - 520



**Basic pedestal on castors**  
Cassettiera basica su ruote  
Caisson de base avec roulettes

W/L/L - 398  
H/H/H - 540



**Melamine pedestal on castors**  
Cassettiera melaminica su ruote  
Caisson melaminé avec roulettes

W/L/L - 398  
H/H/H - 540



**Service unit on castors**  
Mobile di servizio su ruote  
Meuble de service avec roulettes

W/L/L - 775  
H/H/H - 540



**Structural pedestals with built-in handle**  
Cassettiere strutturali con maniglia gola  
Caissons structural avec poignée à rainure

W/L/L - 416  
D/P/P - 400-600  
H/H/H - 720



# modular cabinets

By using the here below components, it is possible to create different modular cabinets: single or double sided, with castors or on feet.

Con gli elementi sotto indicati si possono creare contenitori modulari monofacciali o bifacciali, con ruote o su piedini.

Avec les éléments ci-dessous vous pouvez créer des meubles modulaires uniface ou à deux faces avec roulettes ou pieds.



W/L/L - 400  
D/P/P - 398  
H/H/H - 569



W/L/L - 400  
D/P/P - 398  
H/H/H - 569



W/L/L - 400  
D/P/P - 398  
H/H/H - 569



W/L/L - 400  
D/P/P - 398  
H/H/H - 569



W/L/L - 800  
D/P/P - 398  
H/H/H - 569



W/L/L - 800  
D/P/P - 398  
H/H/H - 569



W/L/L - 800  
D/P/P - 398  
H/H/H - 569

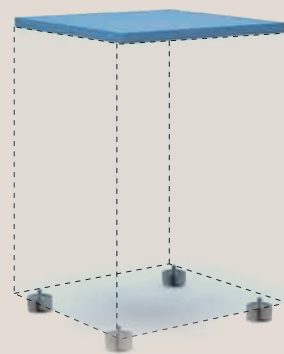

W/L/L - 400-800-1200-1600  
D/P/P - 436 / 454  
H/H/H - 610

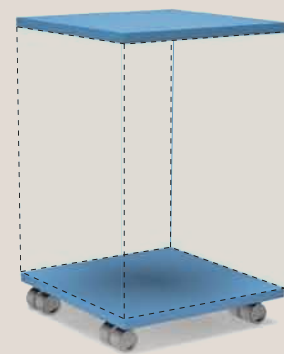

W/L/L - 400-800-1200-1600  
D/P/P - 436 / 454  
H/H/H - 640

Configurations can be single or double sided. Le configurazioni possono essere monofacciali o bifacciali. Les compositions peuvent être uniface ou à deux faces.



Example of double sided composition. Esempio composizione bifacciale. Exemple de composition à deux faces.

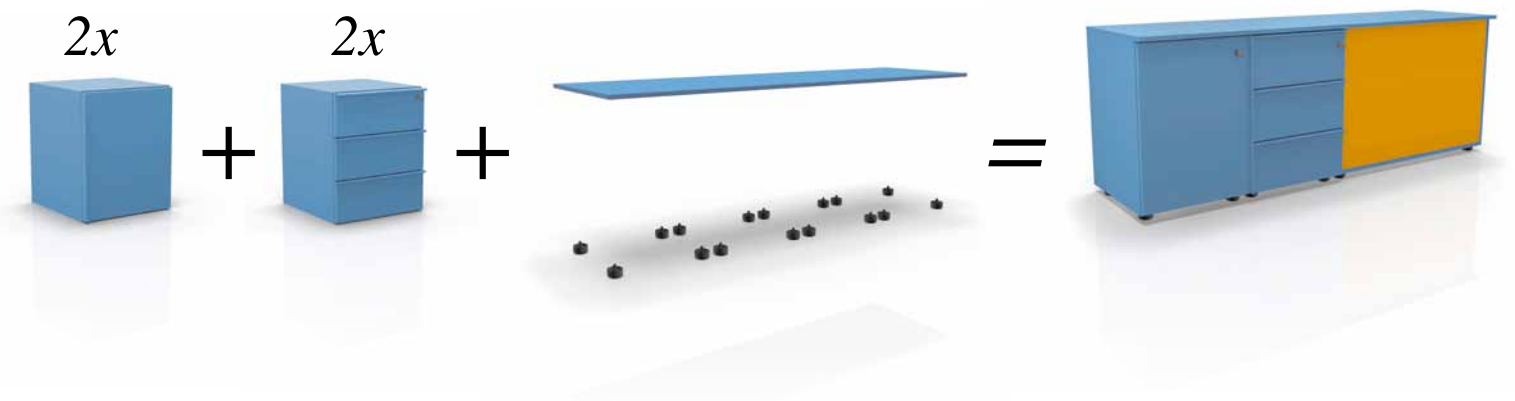

Example of storage positioning. Esempio posizionamento contenitori. Exemple de disposition des meubles.

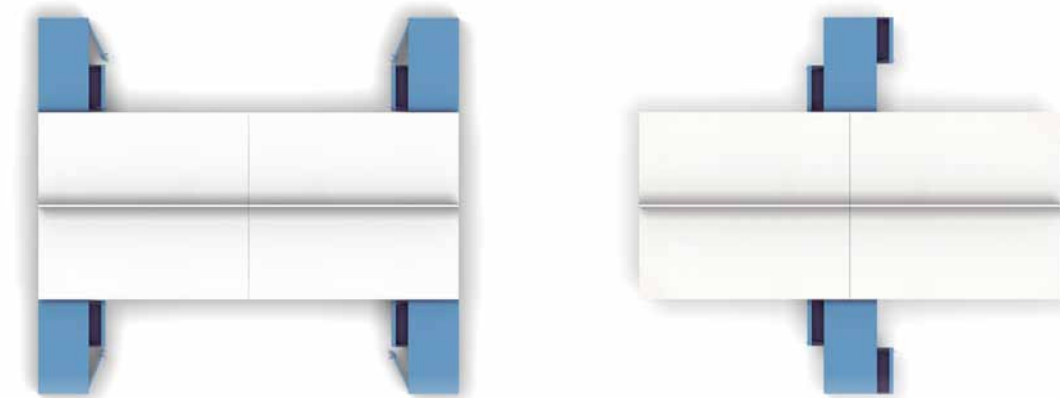



# finishes & colors

## MELAMINE / MELAMINICI / MÉLAMINE



038 Bianco      056 Silicio      041 Titanio      030 Olmo      040 Nocino



White + Olmo edge  
Bianco + bordo Olmo  
Blanc + bord Orme

037 Bianco + Olmo

## METAL FINISH / FINITURE METALLICHE / FINITIONS MÉTAL



053 Bianco      069 Titanio

## FABRIC COVER FOR ELECTRIFICABLE LEG / TESSUTO PER RIVESTIMENTO GAMBA ELETTRIFICABILE REVÊTEMENT EN TISSU POUR PIED ELECTRIFICABLE

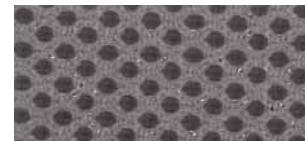

047 Grigio

## MATT LACQUERED / LACCATI OPACHI / LAQUÉ MAT



401 Bianco      402 Avorio      403 Crema      404 Canapo      405 Grigio chiaro



406 Tortora      407 Té verde      408 Verde oliva      409 Verde scuro      421 Ocra



425 Giallo      411 Zucca      422 Orange      412 Rosso vivo      413 Amarena



414 Melanzana      415 Lilla      423 Azzurro polvere      410 Blu marine      424 Denim



426 Blu      418 Fondente      416 Marron glacé      417 Titanio      419 Grigio carbone

420 Nero

## LACQUERED GLASS (ONLY YARD) / VETRO LACCATO (SOLO YARD) / VERRE LAQUÉ (SEULEMENT YARD)



591 Bianco



# fabrics

## CAT.A - STRETCHY 3D / STRETCHY 3D / STRETCHY 3D

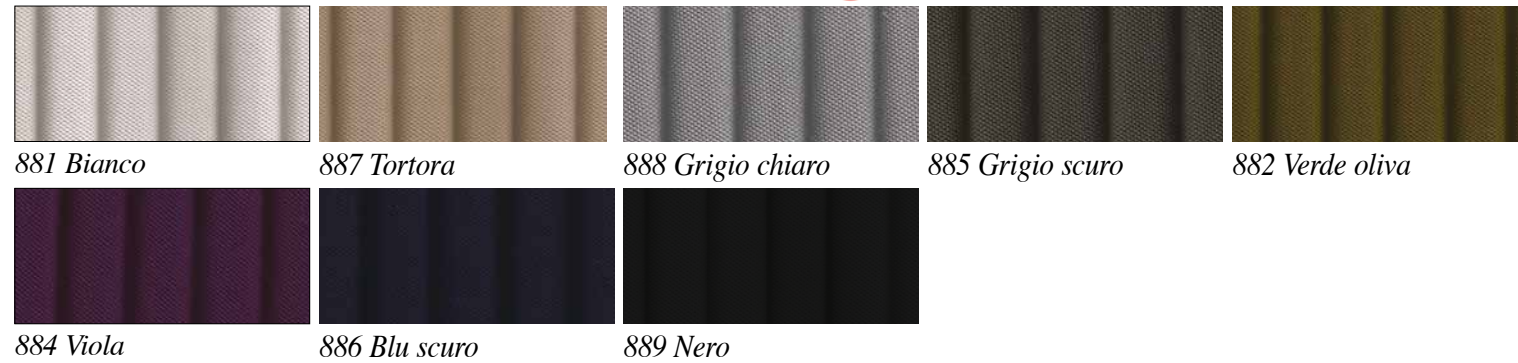

## CAT.B - FAUX-LEATHER 3D / ECOPELLE 3D / SIMILCUIR 3D



## CAT.C - NATIVA / NATIVA / NATIVA



## CAT.D - STOPFIRE / STOPFIRE / STOPFIRE



## CAT.E - FAUX-LEATHER / ECOPELLE / SIMILCUIR



## CAT.F - 100% PURE NEW WOOL / 100% PURA LANA VERGINE / 100% PURE LAINE VIERGE

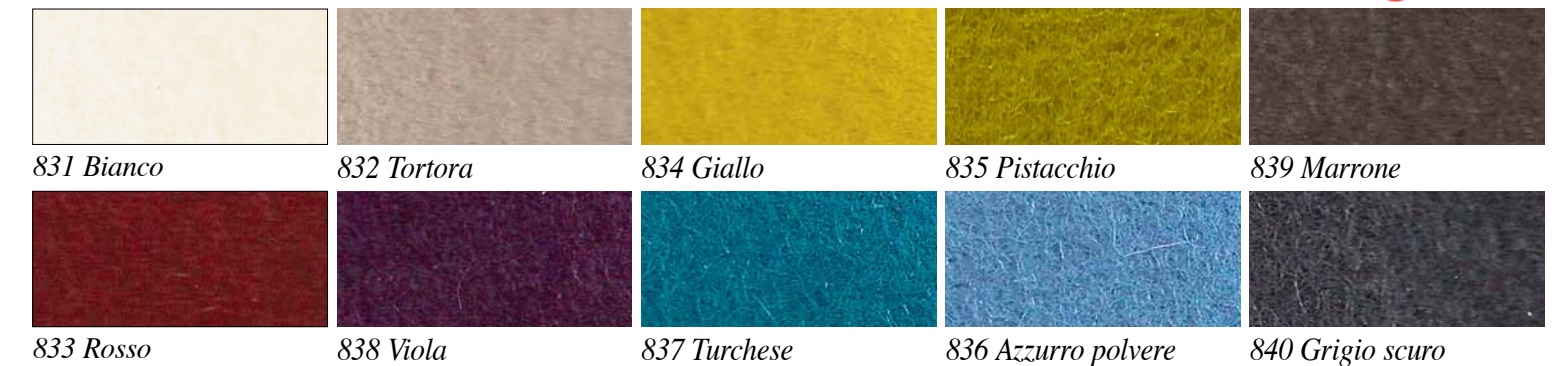

## CAT.M - 100% PURE NEW WOOL 3D / 100% PURA LANA VERGINE 3D / 100% PURE LAINE VIERGE 3D



Colours for reference only and may vary from originals.  
 Campioni colore indicativi, possono differire dall'originale.  
 Echantillons de coloris indicatifs, ils peuvent différer de l'original





## *Credits*

<b>Concept</b>	<i>consilia.it</i>
<b>Art</b>	<i>Mattia Peroni</i>
<b>Rendering</b>	<i>Studio Gabriotti</i> <i>Studio Mazzer</i>
<b>Photo</b>	<i>Studio Gabriotti</i>
<b>Art buyer</b>	<i>Carla Bernardis</i>

9511674

June 2015