

ISSUE No 2 - 2022

NOAH
OFFICE

4MARIANI

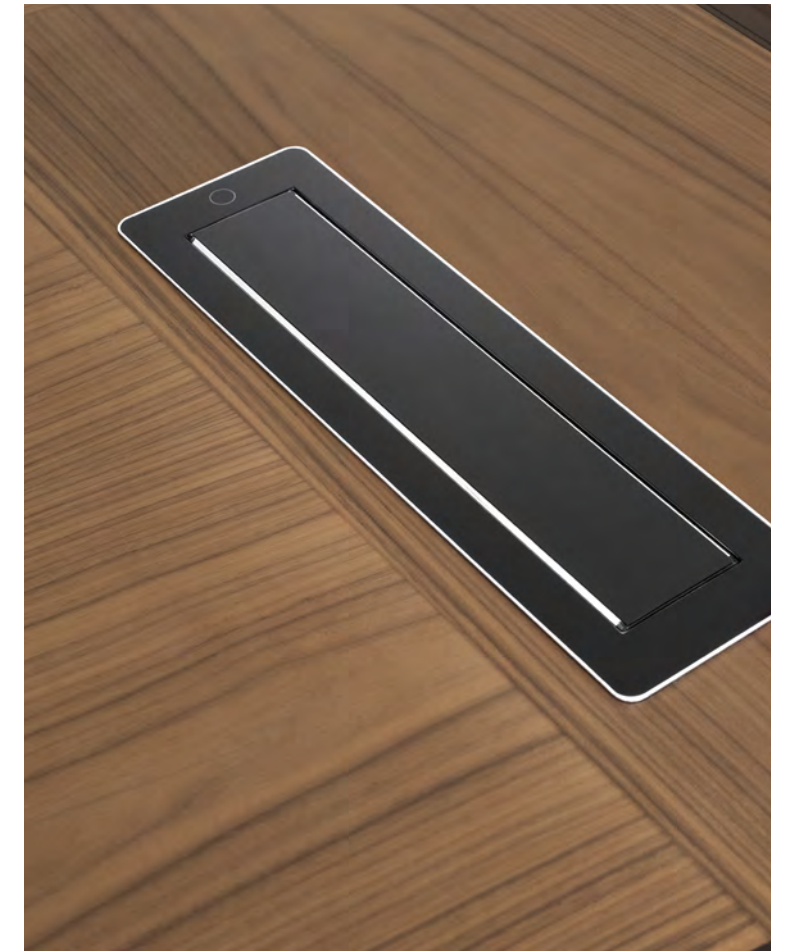



Noah desk

La scrivania è un perfetto alleato per il lavoro da casa. Nasce così Noah, un oggetto di design dalla struttura ricercata che, come una piccola architettura, consente di ricreare un vero e proprio angolo di lavoro all'interno dell'ambiente domestico, rispettando gli arredi preesistenti. Le linee asimmetriche della pianta rettangolare – con un lato corto e uno lungo inclinato – restituiscono leggerezza visiva e i tanti dettagli funzionali evidenziano il suo valore estetico: il ripiano per i libri sul lato visitatori, la cassettera e l'antina lato utilizzatore per riporre con ordine i documenti e il pc, le maniglie in legno massello e i cassettini incassati nello spessore del top. Il piano è in legno di frassino tinto grafite oppure noce canaletto fiammato effetto cera con bordi e sottomano rivestiti in cuoio.

The desk is a perfect ally for home-working. That's why Noah was born; a design item with a refined structure that, like a small piece of architecture, allows you to recreate a real working corner within the home, while respecting the existing furnishings. The asymmetrical lines of the rectangular plan – with one short side and the opposite long sloping side – return visual lightness and the many functional details highlight its aesthetic value: the shelf for books on the visitor's side, the chest of drawers and the door on the user's side for a tidy storage of documents and PC, the solid wood handles and the drawers embedded in the thickness of the top. The top is veneered in graphite stained ash wood or in veined black walnut wood with edges and writing pad covered in saddle leather.

DETTAGLIO VANO PORTA DOCUMENTI E ANTA RIVESTITA IN CUIO CON CUCITURE A VISTA. A DESTRA INTEGRATO NEL PIANO SPORTELLO PASSACAVI.

DETAIL OF DOCUMENT COMPARTMENT AND SADDLE LEATHER COVERED DOOR WITH EXPOSED SEAMS. ON THE RIGHT INTEGRATED IN THE TOP CABLE GROMMET DOOR.

LA SCRIVANIA DIREZIONALE PER LA CASA RACCHIUDE IN SÉ TUTTO IL SAPER FARE DELL'AZIENDA, CONIUGANDO ARTIGIANALITÀ, QUALITÀ, SAPIENTE LAVORAZIONE DEL CUIO E ATTENZIONE PER I PARTICOLARI.

THE EXECUTIVE DESK FOR THE HOME EMBODIES ALL THE KNOW-HOW OF THE COMPANY, COMBINING CRAFTSMANSHIP, QUALITY, SKILLED LEATHER PROCESSING AND ATTENTION TO DETAILS.

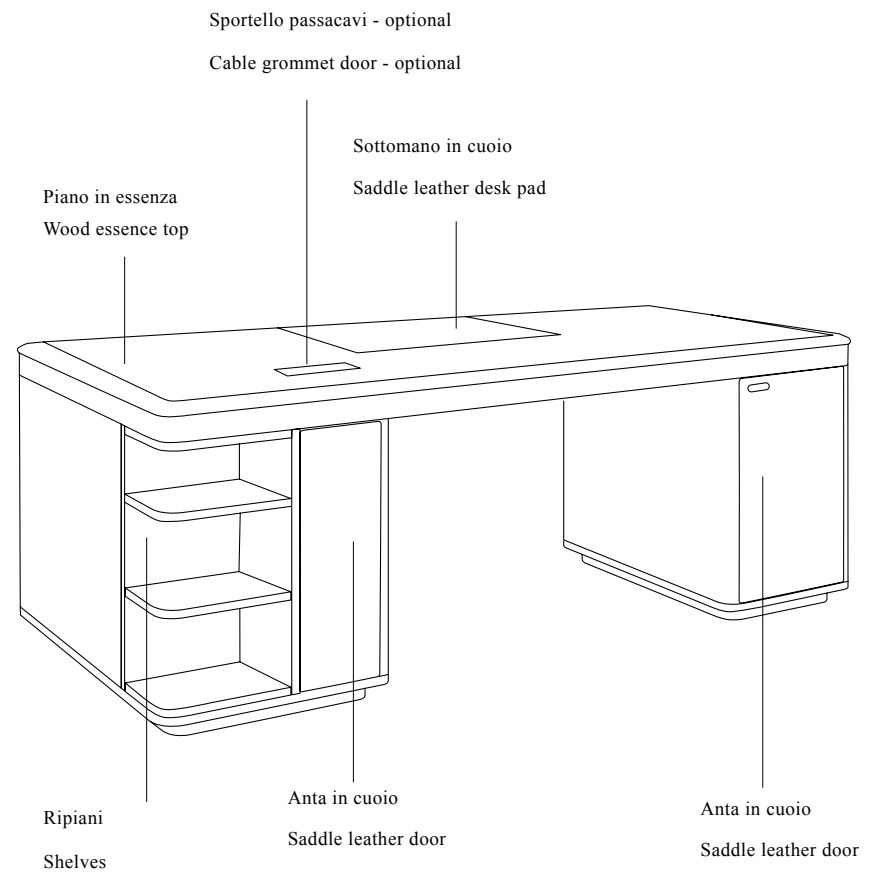



Technicals Noah home/office desk

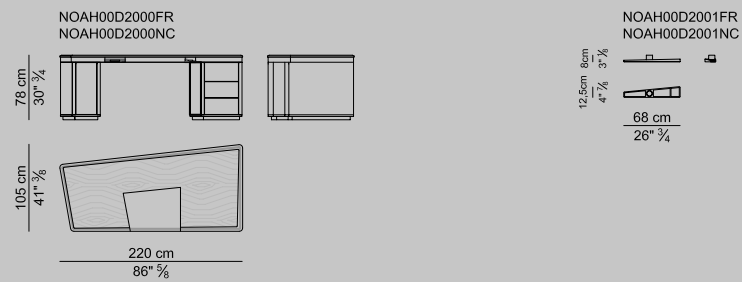

Il piano è sostenuto da due mobili fissi con dimensioni diverse realizzati in nobilitato nero con fianchi sempre rivestiti in cuoio o in pelle. Il mobile sinistro piu' stretto ha un'anta in nobilitato nero rivestita in cuoio o pelle dal lato visitatore e un'anta in pannello di particelle di legno impiallacciata in essenza dal lato utilizzatore. Il mobile destro piu' largo ha un'anta in nobilitato nero rivestita in cuoio o pelle ed una zona a giorno in pannello multistrato impiallacciato in essenza dal lato visitatore; dal lato utilizzatore invece è dotato di 4 cassetti in pannello di particelle di legno impiallacciati in essenza.

The top is supported by two fixed units with different dimensions made in black melamine coated panels with sides always covered in saddle leather or leather. The narrower left cabinet has a black melamine coated panel door covered in saddle leather or leather on the visitor side and a door in particleboard panel veneered on the user side. The wider right-hand cabinet has a black melamine coated panel door covered in saddle leather or leather and an open unit in veneered plywood on the visitor side; on the user side it is equipped with 4 drawers in particleboard panel veneered.



Technicals Garbo workchairs

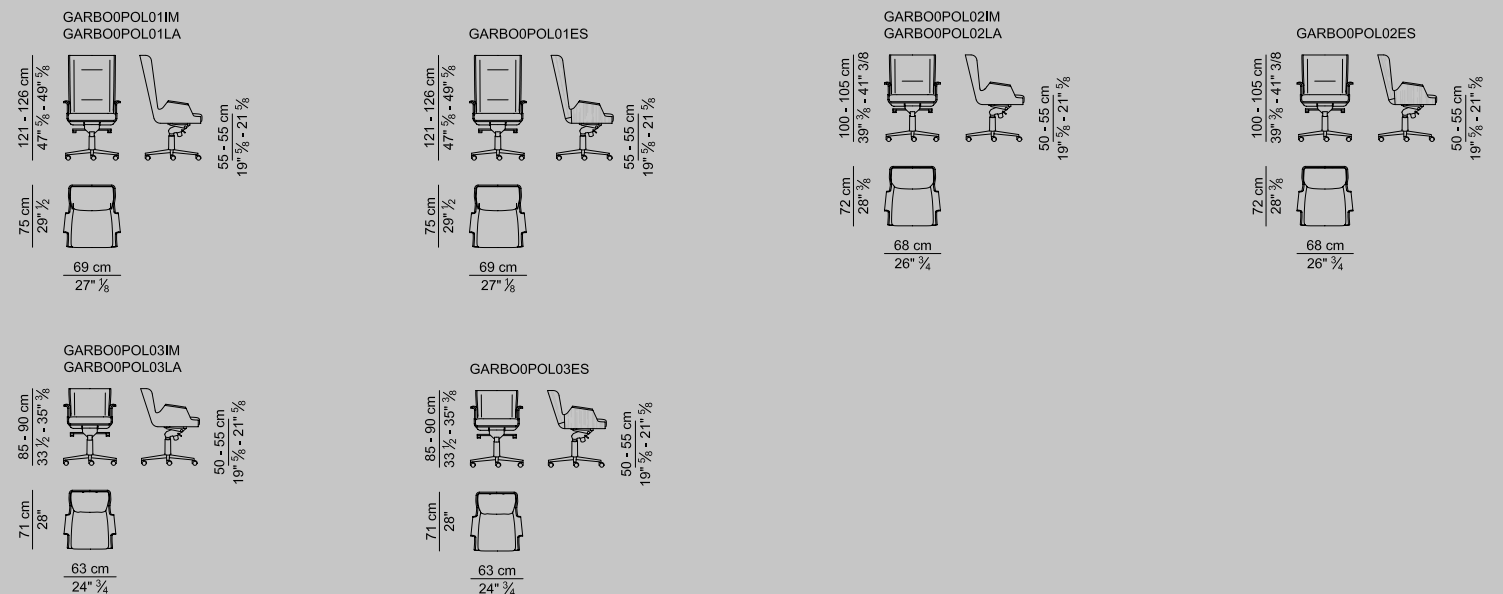



Herman bookcase

Sapere artigianale e design si incontrano nella libreria Herman in un gioco di pieni e di vuoti per adattarsi perfettamente a tutti gli ambienti living e ufficio. Sapientemente studiata nei minimi dettagli, la libreria nasce dalla scelta accurata dei materiali pregiati: il top, il basamento e lo schienale centrale sono rivestiti in cuoio, i fianchi e i ripiani sono realizzati in essenza di frassino tinto grafite o in noce canaletto fiammato effetto cera, i divisori verticali in vetro fumè.

Expertise meet design in the Herman bookcase in a game of solids and voids to adapt perfectly to all living and office environments. Expertly studied in the smallest details, the bookcase is born from the careful choice of precious materials: the top, the base and the central backrests are covered in saddle leather, the sides and shelves are veneered in graphite stained ash wood or in veined black walnut wood with wax effect finish while the vertical partitions are in smoked glass.





Technicals Woody armchairs

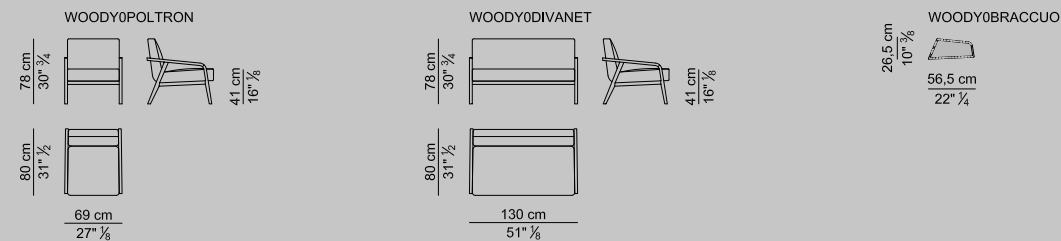

Woody gioca con la leggerezza delle linee ma avvolge con dettagli forme morbidi: una poltrona di piccole dimensioni che combina perfettamente le geometrie lineari con il design arrotondato e confortevole della struttura.

Woody plays with the lightness of the lines but wraps with details soft forms: an armchair of small dimension that combines perfectly the linear geometries with the rounded design and comfortable structure.



Technicals Herman bookcase

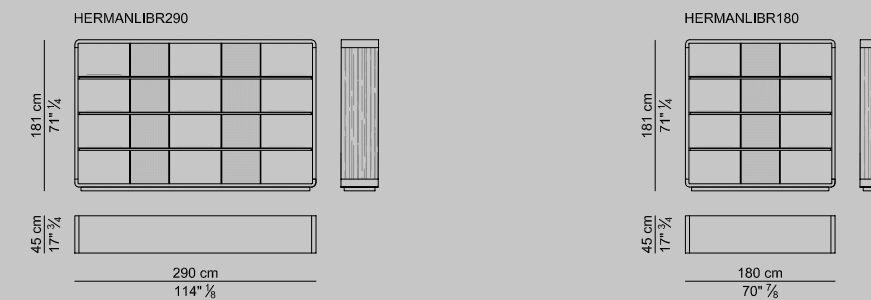

Disponibile in due dimensioni, Herman presenta una facciata aperta – che si chiude solo al centro con lo schienale rivestito in cuoio – mentre i fermi, che sono collocati sui ripiani per bloccare i libri, diventano a loro volta elementi di decoro.

Available in two sizes, Herman has an open side – which closes only in the center with the backrest covered in saddle leather – while the edges, which are placed on the shelves to avoid the books from falling, become themselves decorative elements.

In questa e nella pagina successiva Noah scrivania in frassino tinto grafite e cuoio Privilege CF 217, Flora poltrona in pelle Women PX Agatha e interno in Privilege PF 5055, Gill poltrone in pelle Privilege PF 5014 e interno in tessuto Via della Spiga 2, Herman libreria in frassino tinto grafite e cuoio Privilege CF 217.

On this page and the next Noah desk in graphite-stained ash and saddle leather Privilege CF 217, Flora armchair in leather Women PX Agatha with internal part in leather Privilege PF 5055, Gill armchairs in leather Privilege PF 5014 with internal part in fabric Via della Spiga 2, Herman bookcase in graphite-stained ash and leather Privilege CF 217.







Flora work chair

Flora è la poltrona direzionale che si distingue per comodità ed eleganza. La struttura in multistrato curvato è rivestita in pelle in tinta o in contrasto, abbinandosi nelle cromie alla scrivania bicolore Noah. Una seduta ergonomica e versatile che rispetta ogni esigenza di utilizzo, grazie al basamento girevole, con meccanismo basculante e regolabile che consente i liberi spostamenti nello spazio e garantisce il miglior comfort d'utilizzo.

Flora is the executive armchair that stands out for its comfort and elegance. The curved plywood frame is upholstered and covered in matching or contrasting leather, matching the colors of the Noah desk. An ergonomic and versatile seat that meets every need of use, thanks to the swivel base, with tilting and adjustable mechanism that allows free movement in space and guarantees the best comfort of use.





A black grid shelving unit with four rows and five columns. The shelves are filled with various decorative items and books. The top row contains a black vase, a silver vase, a stack of books including 'IL MONDO DELLA MODA', a black sphere, and a large green plant. The second row features a stack of books, a grey box, a row of five black books, a white vase, a black vase, a black sphere, a stack of books including 'NATURA' and 'Architecture without shadow', and another stack of books. The third row has a stack of books, a black box, a row of four black books, a white vase, and a black vase. The bottom row contains a stack of books including 'TOM FORD' and 'AVRIL MAI JUIN', and a black box.

A brown leather sofa with a ribbed backrest and a metal frame. The sofa is positioned on the left side of the image, facing right.

A round coffee table with a stack of books. The top book is 'TEMPS CHANEL' by ASSOULINE. Below it are 'EIKO ISHIOKA' and 'INTERACTIVE'. Other books are visible in the background.



Technicals Up&Down chaise longue

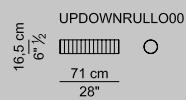
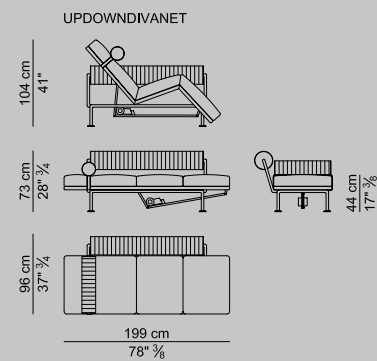

Up&Down è la chaise longue 4Mariani disponibile in tessuto o pelle, adatta alla zona living come alle sale di attesa e agli uffici. La struttura in tubolare d'acciaio è dotata di meccanismo di movimento sincronizzato di sedile e poggia gambe mosso da motore elettrico.

Up & Down is the 4Mariani chaise longue available in fabric or leather, suitable for the living area as well as waiting rooms and offices. The tubular steel frame is equipped with a mechanism that allows a synchronized movement of backrest and footrest through an electric motor



Technicals Gill workchair

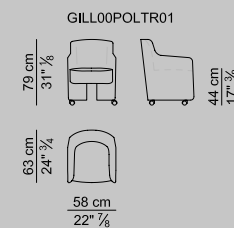

Gill definisce una nuova interpretazione del comfort offrendo un'esperienza di estrema comodità per una durata senza limiti di tempo. La poltroncina a pozzetto imbottita ha una struttura in acciaio annegato in poliuretano espanso schiumato a freddo in stampo, ed è rivestita in tessuto o in pelle; nella versione su ruote è facile spostarla fra le diverse stanze.

Gill defines a new interpretation of comfort by offering an experience of extreme comfort for a duration without time limits. It integrates into any context, from the dining table to meeting rooms. The padded tub armchair has a steel frame embedded in a cold formed polyurethane foam made in mould and is upholstered in fabric or leather; in the version on wheels it is easy to move it between the different rooms.



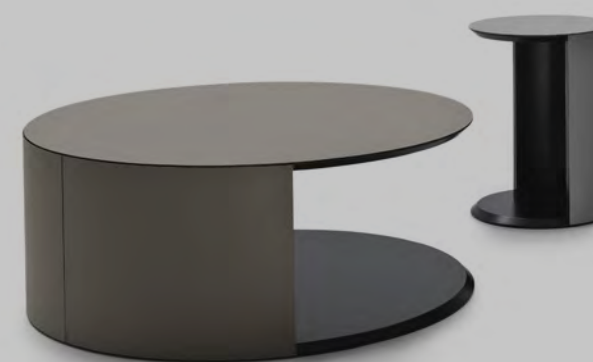

Technicals Pablo sofa and armchairs

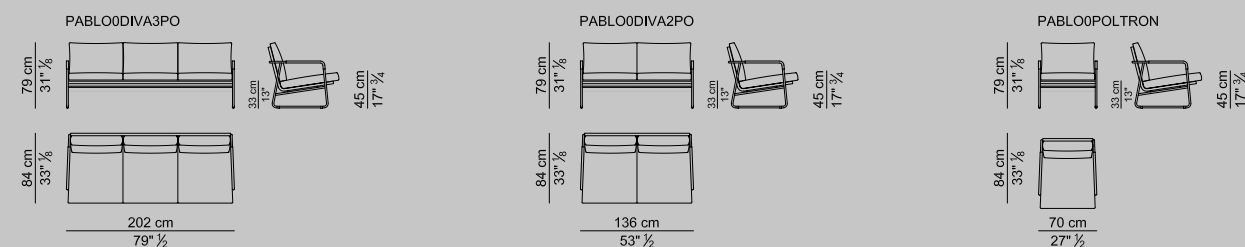

La collezione Pablo è caratterizzata da un segno grafico essenziale e da tratti minimali che restituiscono una grande adattabilità alle più diverse esigenze di arredo per la casa, l'ufficio e il contract. La struttura della seduta è in multistrato curvato imbottito, i cuscini di seduta e di schienale sono rivestiti in pelle o in tessuto mentre i braccioli, sono impreziositi con un decoro di cuoio intrecciato in colore nero o rosso bulgaro. Tra dettagli ricercati e design contemporaneo, s'intesse così un dialogo serrato tra funzionalità, eleganza e qualità.

The Pablo collection is characterized by an essential graphic design and minimal features that give great adaptability to the most different furnishing needs for the home, office and contract. The seat frame is in curved plywood padded, the seat and back cushions are covered in leather or fabric while the armrests are embellished with a black or red woven saddle leather straps decoration. Between refined details and contemporary design, a close dialogue between functionality, elegance and quality is interwoven.

Technicals Papier coffee tables

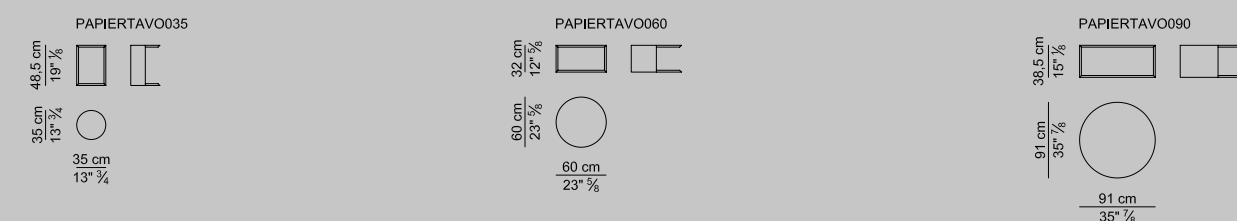

Papier è una collezione di complementi di arredo caratterizzata da essenzialità e leggerezza, ottenute grazie all'utilizzo di materiali e tecniche di lavorazione esclusivi. Come fogli di carta impalpabili i lembi di cuoio si modellano perfettamente sulle forme del legno, dalle superfici piane alle curvature degli angoli.

Papier is a collection of furnishings complements characterized by essentiality and lightness, obtained thanks to the use of materials and techniques of exclusive production. As very fine sheets of papers, the edges of saddle leather model themselves perfectly to the shapes of the wood, from the flat surfaces to the bending of the corners.